

KUVIO 100 (KUV100)

GENERAL DATA



HIGH EFFICIENCY IN-LINE MIXED FLOW FAN CONSTRUCTED IN SELF-EXTINGUISHING PLASTIC RESIN AND RESISTANT TO AGGRESSIVE CHEMICAL AGENTS.

MANUFACTURING FEATURES:

High efficiency In-line mixed flow fan with motor-holder enclosures, end cones and mixed flow impellers constructed in self-extinguishing plastic resin with a mineral-based additive to ensure dimensional stability. The side cones incorporate the fan's anchoring brackets onto the target surface for safe, quick installation. Designed to allow the assembly or disassembly of the fans without manipulating the ducts.

Standard version and timer version (T). Two-speed (sizes 100-160) and 3 speed (200-315) monophasic motor with thermal overload cut-out and shafts turning on ball bearings to guarantee long life continuous work (at least 30.000 hours at the maximum plate temperature. Standard voltages 220-240V 50Hz and 60 Hz. Speed adjustable with accessories.

Maximum working temperature in continuous: 50°C

IP44 protection. IMQ Safety certificate to guaranty the electromechanical compatibility.

APPLICATIONS:

Designed for duct supply and exhaust ventilation systems that require excellent response in terms of high pressure and air flow, while keeping noise under control.

It can be used in many small and medium ventilation installations for air renewal such as:

- Bathrooms and changing rooms.
- Commercial offices.
- Extraction in domestic kitchens after the extraction hood.
- Schools
- Waiting room.
- Commercial premises, laundries, shops, bars, restaurants ...
- Laboratories.

PERFORMANCE CURVE

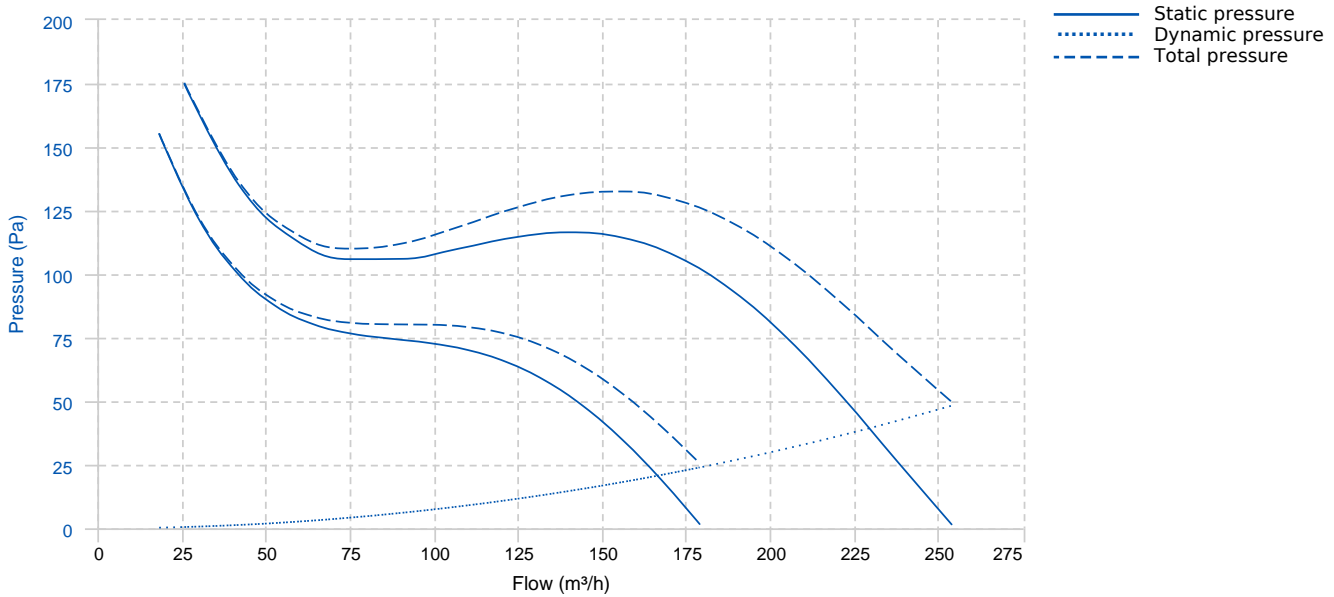

TECHNICAL DATA

Fan

Approx. weight 1.8 kg Max. Flow 260 m³/h

Motor

Power 0,02/0,023 kW RPM 2030/1520 I max. (230V) 0,09/0,11 A

DIMENSIONS

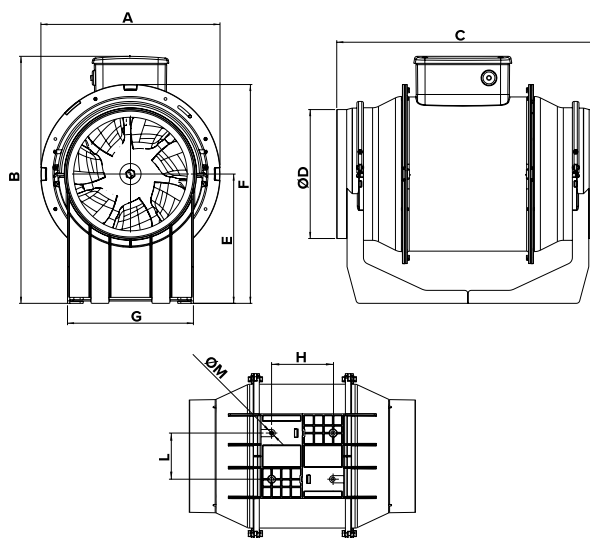

Dimensions (mm)

A	188.5	B	211	C	303	D	96	E	101.5
F	189	G	90	H	60	L	80	M	5,5

WIRING DIAGRAM

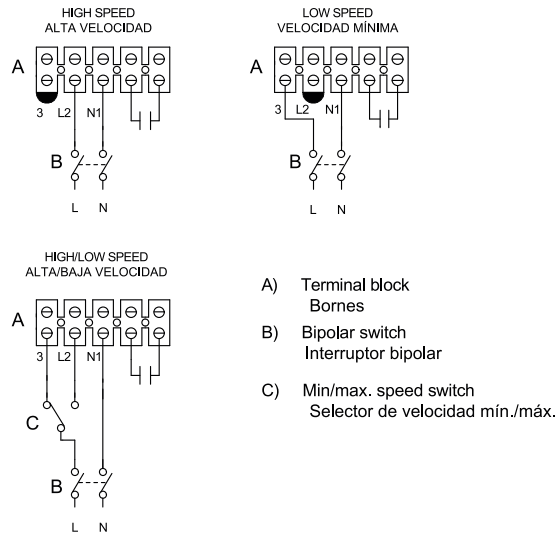

ACCESSORIES



MANUAL SINGLE PHASE SPEED CONTROLLER
REG 1,5A
REF: 960710015



SPEED SELECTOR SWITCH
INT 3V 3A
REF: 960000603



ANTI-VIBRATION JOINT
JE 45
REF: 300719201



CIRCULAR SOUND ATTENUATOR IN GALVANISED STEEL
SILC-MINI 100
REF: SILCM100



BACKDRAUGHT SHUTTER
BDC Ø 100
REF: BDC100

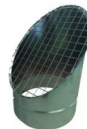

CIRCULAR OUTDOOR FLANGE WITH BIRD GUARD
VISC Ø100
REF: VISC100