

HydroControl VFC, VFN, VFR

Double regulating and commissioning valves PN 16/PN 25/PN 6, DN 20...400



The HydroControl VFx (short designation, representative of VFC, VFN und VFR) is a flanged double regulating and commissioning valve for the static hydronic balancing of pipelines in closed heating and cooling systems. It offers a measuring function via the valve seat.

The HydroControl VFx consists of a flow optimised Y-pattern body with flanged connection, a valve insert with double O-ring sealing, ergonomically designed handwheel, low pitch and sophisticated cone shaped plug as well as two Classic measuring valves. All functions are accessible from the top and include the following:

- Accurate flow regulation
- Reproducible, blockable and lead sealable infinitely adjustable presetting
- Pipeline shutoff
- Flow measurement connection
- Optional filling, bleeding and draining
- Optional connection of the impulse tube of a differential pressure regulator

Features

- + Complete portfolio up to nominal size DN 400
- + Flanges with hole circles according to EN1092-2 PN 16, PN 25, PN 6 or according to ANSI class 150
- + Made of cast iron, nodular cast iron or bronze

Variants

The HydroControl VFC is the standard valve with cast iron body. It is available in PN 16 up to DN 400 and in PN 6 or ANSI.

The HydroControl VFN is the PN 25 variant with nodular cast iron body.

The HydroControl VFR is a PN 16 variant with bronze body and bonnet. It is suitable for difficult media.

Product Details

Technical Data

	HydroControl VFC	HydroControl VFN	HydroControl VFR
Nominal sizes	DN 20...400 ¾...16"	DN 65...300	DN 50...200
Flange versions	According to EN 1092-2 PN 16 ¹ According to EN 1092-2 PN 6 According to ANSI class 150	According to EN 1092-2 PN 25	According to EN 1092-2 PN 16
Length	According to EN 558, basic series 1 ²		
Operating temperature	-10...150 °C	-20...150 °C	-20...150 °C
Operating pressure	Max. 16 bar Max. 20 bar for cold water With flanges PN 6: max. 6 bar	Max. 25 bar	Max. 16 bar Max. 20 bar for cold water
Medium	Heating and cooling water according to VDI 2035 or ÖNORM 5195 Water and glycol mixtures with a max. glycol content of 50%		Heating and cooling water according to VDI 2035 or ÖNORM 5195 Water-glycol mixtures with a max. glycol content of 50 % Cold salt water up to 38 °C Service water
Kvs values	4.8...3,750	98...1,600	36...815
Storage temperature	-20...60 °C		

Functions

Flow Regulation

Flow regulation is done by limiting the valve lift and hence the opening between plug and seat. The low pitch allows very precise setting. The plug position is displayed on a scale on the handwheel. This value is the presetting value.

The HydroControl has an almost linear characteristic line and a wide flow range evenly graded over all nominal sizes. As is typical for regulating valves, the control quality decreases the smaller the opening is between plug and seat. Very small presettings are therefore not recommended for the HydroControl and are generally not specified.

Presetting

- Infinitely: all intermediate values are adjustable
- Reproducible: when the valve is closed, it can only be opened up to the set presetting value
- Blockable: Valves up to and including DN 50 can be blocked at the presetting position, i.e. locked against opening or closing. The blocking set item no. 1060180 is required for this (see chapter Accessories, further on)
- Lead sealable: the valve can be additionally lead sealed, e.g. with with the wire seal kit item no. 1089091 (see chapter Accessories)

Shutoff

Turning the handwheel clockwise until it stops shuts off the pipeline tightly.

¹ EN 1092-2 PN6 / PN16 / PN25 corresponds to ISO 7005-2 PN 6 / PN 16 / PN 25

² EN 558, basic series 1 corresponds to ISO 5752, series 1

Flow Determination

Each HydroControl VFx is equipped with two Classic measuring valves in order to be able to measure the differential pressure and thus determine the flow rate. The Oventrop OV-DMC 3 measuring device contains the required measuring needles and the characteristic lines of all HydroControl VFx are stored as standard.

Due to the patented measuring arrangement (measuring chamber is routed around the valve insert to the measuring connection), the pressure difference measured at the measuring valves almost matches the actual pressure difference of the valve.

FILLING, DRAINING AND BLEEDING

For filling, draining and bleeding, one or both Classic measuring valves can be replaced with fill and drain ball valves. For replacement, the valve must be depressurised. To ensure tightness, use the fill and drain ball valve item no. 1060191 (see chapter Accessories).

A flow determination can still be carried out, as the necessary adapters for connection to fill and drain ball valves are included with the OV-DMC 3 measuring device.

IMPULSE TUBE CONNECTION

To connect an impulse tube, one of the measuring valves must also be replaced with a fill and drain ball valve. The impulse tube of the differential pressure regulator is connected to the hose connection of the fill and drain ball valve. Flow determination by the HydroControl VFx is then only possible with a separate measuring adapter item no. 1060299 (see chapter Accessories).

CONNECTION OF AN OV-DMC 3

The measuring hoses of an OV-DMC 3 measuring device can be connected to the Classic measuring valves with needle adapters. The needle adapters are supplied with the OV-DMC 3.

Materials

Component	Nominal size	HydroControl VFC	HydroControl VFN	HydroControl VFR
Handwheel assembly	All	Polyamide plastic PA6	Polyamide plastic PA6	Polyamide plastic PA6
Body	up to DN 300	Cast iron ³	Nodular cast iron GGG-50 ⁴	Bronze ⁵
	DN 350 and DN 400	Nodular cast iron GGG-50	—	—
Bonnet	DN 20...50	Bronze	—	Bronze
	DN 65...80	Cast iron	Bronze	Bronze
	DN 100...150	Bronze	Bronze	Bronze
	DN 200...300	Nodular cast iron GGG-40 ⁶	Nodular cast iron GGG-40	Bronze
	DN 350 and DN 400	Nodular cast iron GGG-50	—	—
Bonnet sealing	All	2 x EPDM O-ring	2 x EPDM O-ring	2 x EPDM O-ring
Spindle	All	DZR brass ⁷	DZR brass	Stainless steel
Spindle sealing	All	2 x EPDM O-ring	2 x EPDM O-ring	2 x EPDM O-ring
Plug	DN 20...50	DZR brass	—	Bronze
	DN 65...80	DZR brass	Bronze	Bronze
	DN 100...400	Bronze	Bronze	Bronze
Seat sealing	All	PTFE	PTFE	PTFE
Measuring valves	All	DZR brass	DZR brass	DZR brass

³ Cast iron EN-GJL-250 according to EN 1561 (GG-25)

⁴ Nodular cast iron EN-GJS-500-7 according to EN 1563 (GGG-50)

⁵ Bronze CC491K (Rg5)

⁶ Nodular cast iron EN-GJS-400-15 according to EN 1563 (GGG-40)

⁷ Dezincification resistant brass CW602

Dimensions

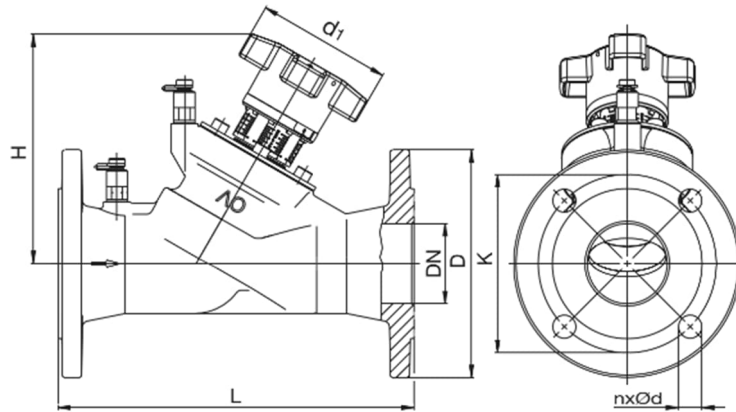

DN / Inch	All VFX			VFC, VFR PN 16			VFC PN 6			VFN PN 25			VFC ANSI		
	L	H	d1	D	K	n x Ød	D	K	n x Ød	D	K	n x Ød	D	K	n x Ød
20 / ¾	150	118	70	105	75	4 x 14	90	65	4 x 11				99	70	4 x 16
25 / 1	160	118	70	115	85	4 x 14	100	75	4 x 11				108	79	4 x 16
32 / 1¼	180	136	70	140	100	4 x 19	120	90	4 x 14				118	89	4 x 16
40 / 1½	200	136	70	150	110	4 x 19	130	100	4 x 14				127	98	4 x 16
50 / 2	230	145	70	165	125	4 x 19	140	110	4 x 14				153	121	4 x 19
65 / 2½	290	188	110	185	145	4 x 19	160	130	4 x 14	185	145	8 x 19	185	140	4 x 19
80 / 3	310	203	110	200	160	8 x 19	190	150	4 x 19	200	160	8 x 19	200	152	4 x 19
100 / 4	350	240	160	220	180	8 x 19	210	170	4 x 19	235	190	8 x 23	220	191	8 x 19
125 / 5	400	283	160	250	210	8 x 19	240	200	8 x 19	270	220	8 x 28	250	216	8 x 22
150 / 6	480	285	160	285	240	8 x 23	265	225	8 x 19	300	250	8 x 28	285	241	8 x 22
200 / 8	600	467	300	340	295	12 x 23	320	280	8 x 19	360	310	12 x 28	340	298	8 x 22
250 / 10	730	480	300	405	355	12 x 28				425	370	12 x 31	405	362	12 x 25
300 / 12	850	515	300	460	410	12 x 28				485	430	16 x 31	485	432	12 x 25
350 / 14	980	560	300	520	470	16 x 28							535	476	12 x 28
400 / 16	1.100	655	300	580	525	16 x 31									

All specifications in mm.

Installation

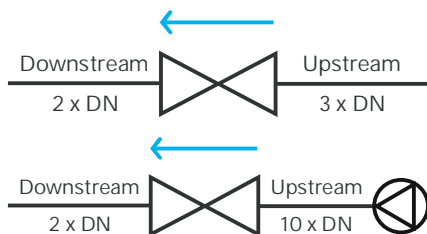

- Calming sections of 3 x DN upstream and 2 x DN downstream of the valve should be provided.
- When installing directly downstream of a pump, a calming section of 10 x DN should be provided.
- The valve must be installed correctly in the flow direction which is indicated by an arrow on the body.

Item Numbers

DN / Inch	HydroControl VFC PN 16	HydroControl VFC PN 6	HydroControl VFC ANSI	HydroControl VFN	HydroControl VFR
20 / ¾	1062646	1062676	1062946		
25 / 1	1062647	1062677	1062947		
32 / 1¼	1062648	1062678	1062948		
40 / 1½	1062649	1062679	1062949		
50 / 2	1062650	1062680	1062950		1062350
65 / 2½	1062651	1062681	1062951	1062451	1062351
80 / 3	1062652	1062682	1062952	1062452	1062352
100 / 4	1062653	1062683	1062953	1062453	1062353
125 / 5	1062654	1062684	1062954	1062454	1062354
150 / 6	1062655	1062685	1062955	1062455	1062355
200 / 8	1062656	1062686	1062956	1062456	1062356
250 / 10	1062657		1062957	1062457	
300 / 12	1062658		1062958	1062458	
350 / 14	1062659		1062959		
400 / 16	1062660		1062960		

Accessories

Thermal insulation shell

Made of polyurethane rigid foam with polystyrene shell. For heating and cooling systems. Operating temperature -10 to 130 °C. Building material class B2 according to DIN 4102. Meets the requirements of Appendix 8 to Sections 69 and 71(1) line ee) of the German Building Energy Act (GEG). Cold insulation: Min. medium temperature 6 °C, shells have to be bonded hermetically. Restricted diffusion tightness at low medium temperature and at high ambient temperature and/or air humidity.

	Suitable for	Item no.
	DN 20	1062581
	DN 25	1062582
	DN 32	1062583
	DN 40	1062584
	DN 50	1062585
	DN 65	1062586
	DN 80	1062587
	DN 100	1062588
	DN 125	1062589
	DN 150	1062590

Spindle extension 35 mm

For valve insulation with commercially available insulation material. Not to be used in combination with the Oventrop thermal insulation shells.

	Suitable for	Item no.
	DN 20...50	1688296
	DN 65...150	1688297

Measuring valve extension

	Suitable for	Item no.
	for all nominal sizes, 80 mm	1060295
	for all nominal sizes, 40 mm	1688295

Blocking set

Consisting of blocking head, seal and sealing wire.

	Suitable for	Item no.
	DN 20...50	1060180

Wire seal kit

10-fold, consisting of seal and sealing wire.

	Suitable for	Item no.
	All nominal sizes	1089091

Identification ring

10-fold, for riser identification, can be clipped onto the handwheel.

	Colour	Item no.
	Blue	1069650
	Red	1069651

Fill and drain ball valve

	Suitable for	Item no.
	All nominal sizes	1060191

Measuring adapter, 2-fold

	Suitable for	Item no.
	All nominal sizes	1060299

Replacement insert

	Suitable for	Item no.
	DN 20	1069006
	DN 25	1069008
	DN 32	1069010
	DN 40	1069012
	DN 50	1069016

Sizing

This data sheet offers you various options to size your HydroControl VFX:

- Use the alignment chart below for a quick sizing across all nominal sizes.
- Use the Kv value tables and flow charts in the "Flow data" section for an accurate determination of the presetting value.
- At the end of the data sheet you will find information on the exact Kv value calculation taking into account the medium temperature. Furthermore, you will find information on the approximate calculation of corrected flow values when using glycol mixtures.

Alignment Chart

The alignment chart allows you to graphically determine the Kv value. Draw a line and place it so that it crosses the desired flow rate (1) on the left scale and the available differential pressure (2) on the right scale - in the example below it is the blue line that crosses the respective scales at 100 m³/h and 20 kPa. Now you can read off the Kv value (3) from the middle scale, in this case 223.

If you draw a line from the Kv-value scale to the right (in the example below, the grey line), you will immediately see which nominal sizes come into question for the required flow rate. For a Kv value of 223, DN 125 to DN 250 are possible. Since control and regulating valves are reluctant to operate at the lower end of their capacity, DN 300 should not be selected.

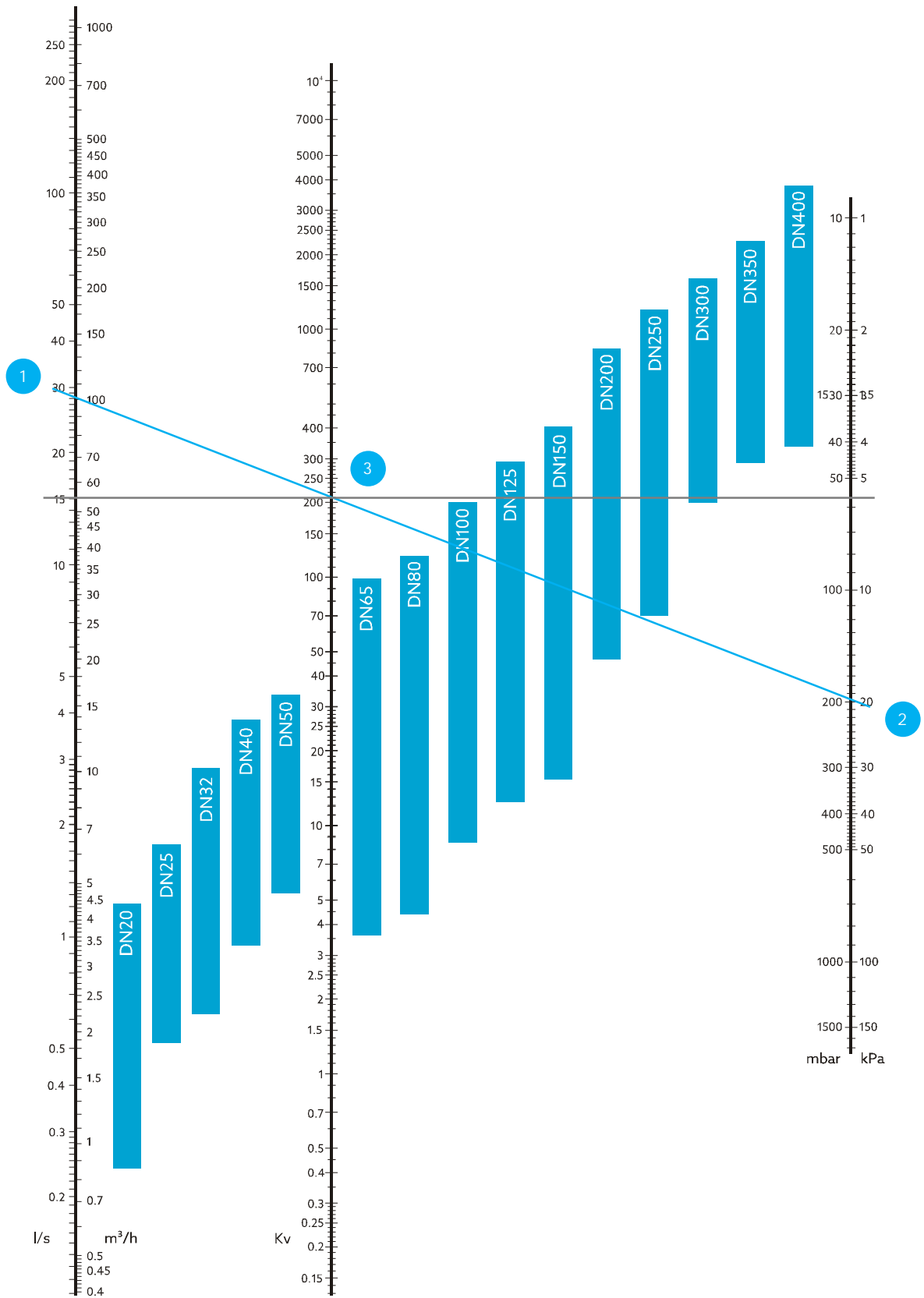

Flow Data DN 20 to DN 50

Kv Values DN 20

Pre-decimal point	Decimal point presetting									
	.0	.1	.2	.3	.4	.5	.6	.7	.8	.9
1	0.42	0.48	0.52	0.55	0.59	0.63	0.67	0.70	0.75	0.79
2	0.83	0.87	0.91	0.95	0.99	1.04	1.08	1.12	1.16	1.20
3	1.25	1.30	1.35	1.41	1.47	1.54	1.61	1.70	1.79	1.89
4	2.00	2.11	2.22	2.33	2.43	2.54	2.65	2.76	2.87	2.98
5	3.09	3.19	3.30	3.41	3.52	3.63	3.74	3.84	3.95	4.06
6	4.17	4.27	4.35	4.43	4.5	4.56	4.61	4.66	4.70	4.74
7	4.77									

Kv Values DN 25

Pre-decimal point	Decimal point presetting									
	.0	.1	.2	.3	.4	.5	.6	.7	.8	.9
1	1.33	1.43	1.53	1.63	1.73	1.83	1.94	2.04	2.14	2.24
2	2.34	2.44	2.53	2.63	2.73	2.83	2.93	3.03	3.12	3.22
3	3.32	3.45	3.58	3.70	3.84	3.98	4.13	4.27	4.42	4.58
4	4.74	4.90	5.07	5.24	5.42	5.60	5.80	6.00	6.20	6.42
5	6.64	6.85	7.03	7.18	7.32	7.44	7.55	7.65	7.74	7.82
6	7.90	7.97	8.03	8.09	8.15	8.20	8.24	8.28	8.32	8.35
7	8.38									

Kv Values DN 32

Pre-decimal point	Decimal point presetting									
	.0	.1	.2	.3	.4	.5	.6	.7	.8	.9
1	1.73	1.92	2.11	2.30	2.49	2.68	2.87	3.06	3.25	3.44
2	3.63	3.82	4.01	4.20	4.39	4.58	4.77	4.96	5.15	5.34
3	5.53	5.73	5.92	6.12	6.31	6.51	6.71	6.90	7.10	7.30
4	7.46	7.69	7.88	8.08	8.27	8.47	8.67	8.86	9.06	9.25
5	9.45	9.68	9.92	10.15	10.35	10.60	10.83	11.05	11.27	11.48
6	11.70	11.96	12.20	12.41	12.62	12.81	13.00	13.17	13.33	13.49
7	13.65	13.78	13.92	14.06	14.18	14.30	14.42	14.54	14.65	14.76
8	14.86	14.97	15.10	15.20	15.31	15.42	15.53	15.64	15.75	15.86
9	15.97	16.08	16.20	16.30	16.41	16.53	16.64	16.75	16.86	16.97
10	17.08									

Kv Values DN 40

Pre-decimal point	Decimal point presetting									
	.0	.1	.2	.3	.4	.5	.6	.7	.8	.9
1	3.27	3.58	3.85	4.18	4.48	4.77	5.06	5.35	5.64	5.92
2	6.20	6.43	6.67	6.90	7.15	7.39	7.64	7.89	8.14	8.39
3	8.69	8.91	9.17	9.43	9.69	9.97	10.25	10.52	10.80	11.09
4	11.38	11.67	11.97	12.27	12.58	12.89	13.20	13.52	13.84	14.17
5	14.51	14.91	15.32	15.75	16.14	16.62	17.10	17.58	18.07	18.59
6	19.13	19.53	19.90	20.25	20.59	20.90	21.21	21.50	21.74	22.04
7	22.30	22.55	22.79	23.03	23.26	23.47	23.70	23.91	24.11	24.31
8	24.51	24.64	24.78	24.90	25.03	25.16	25.29	25.41	25.53	25.65
9	25.77	25.89	26.00	26.12	26.23	26.34	26.45	26.56	26.67	26.77
10	26.88									

Kv Values DN 50

Pre-decimal point	Decimal point presetting									
	.0	.1	.2	.3	.4	.5	.6	.7	.8	.9
1	5.76	6.10	6.41	6.70	6.96	7.24	7.66	8.20	8.66	9.10
2	9.55	9.96	10.36	10.78	11.18	11.57	11.95	12.33	12.69	13.06
3	13.41	13.87	14.32	14.78	15.25	15.56	16.20	16.67	17.14	17.60
4	18.34	18.52	19.01	19.48	19.95	20.55	20.89	21.36	21.83	22.30
5	22.70	23.12	23.54	23.95	24.37	24.80	25.21	25.63	26.04	26.46
6	26.88	27.18	27.48	27.75	28.06	28.31	28.61	28.88	29.15	29.41
7	29.68	29.91	30.15	30.40	30.64	30.88	31.11	31.33	31.57	31.79
8	32.00	32.22	32.44	32.65	32.86	33.06	33.27	33.47	33.67	33.87
9	34.06	34.25	34.44	34.69	34.82	35.00	35.20	35.40	35.60	35.80
10	36.00									

Tolerance Curve

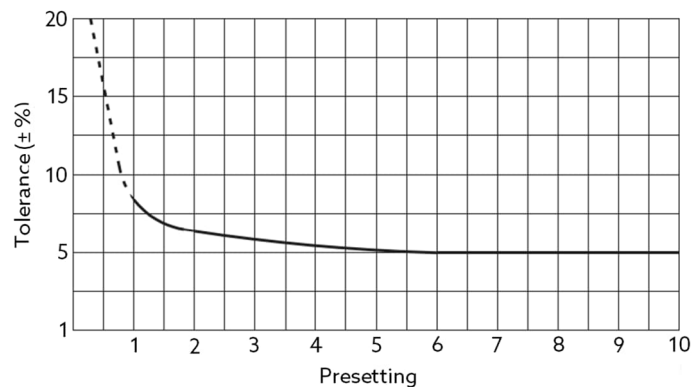

Flow Data DN 65 to DN 150

Kv Values DN 65

Pre-decimal point	Decimal point presetting									
	.0	.1	.2	.3	.4	.5	.6	.7	.8	.9
1	3.60	4.12	4.49	4.86	5.23	5.60	6.43	7.29	8.17	9.07
2	10.00	10.95	11.91	12.92	13.94	15.00	16.66	18.38	20.14	21.95
3	24.00	25.73	27.70	29.74	31.84	34.00	35.93	37.84	39.74	41.63
4	43.50	45.36	47.20	49.03	50.85	52.00	54.45	56.23	58.00	59.74
5	61.00	63.21	64.93	66.63	68.32	70.00	71.69	73.33	74.93	76.48
6	78.00	79.48	80.91	82.31	83.67	85.00	86.12	87.20	88.23	89.23
7	90.00	91.13	92.02	92.89	93.71	94.50	95.27	96.00	96.70	97.36
8	98.00									

Kv Values DN 80

Pre-decimal point	Decimal point presetting									
	.0	.1	.2	.3	.4	.5	.6	.7	.8	.9
1	4.40	4.74	5.17	5.67	6.28	7.00	7.89	8.82	9.78	10.79
2	11.85	12.95	14.11	15.33	16.61	18.65	19.39	20.90	22.51	24.24
3	26.10	27.85	29.61	31.39	33.19	35.00	36.83	38.68	40.55	42.43
4	44.75	46.27	48.21	50.19	52.18	55.20	56.22	58.28	60.36	62.47
5	64.60	66.98	69.32	71.63	73.90	75.45	78.37	80.56	82.72	84.85
6	87.00	89.04	91.00	93.13	95.14	97.55	99.10	101.04	102.96	104.87
7	106.75	108.39	110.00	111.60	113.00	114.50	116.13	117.78	119.27	120.74
8	122.20									

Kv Values DN 100

Pre-decimal point	Decimal point presetting									
	.0	.1	.2	.3	.4	.5	.6	.7	.8	.9
1	8.55	9.58	10.61	11.64	12.67	14.00	14.73	15.76	16.79	17.82
2	18.50	19.88	20.91	21.94	22.97	24.00	26.00	28.13	30.40	32.81
3	35.40	38.18	41.17	44.44	48.02	52.00	55.93	59.89	63.89	67.92
4	72.00	76.11	80.27	84.47	88.71	93.00	97.37	101.62	105.74	109.75
5	112.00	117.46	121.17	124.79	127.52	132.00	135.16	138.47	141.71	144.89
6	148.00	151.94	155.63	159.10	162.38	164.03	168.44	171.26	173.95	176.53
7	179.01	181.37	183.65	185.85	187.96	190.04	192.37	194.66	196.85	198.96
8	201.00									

Kv Values DN 125

Pre-decimal point	Decimal point presetting									
	.0	.1	.2	.3	.4	.5	.6	.7	.8	.9
1	12.45	13.84	15.23	16.62	18.01	19.40	20.94	22.47	24.01	25.54
2	26.60	28.61	30.15	31.36	33.22	34.75	37.18	39.69	42.29	44.97
3	47.75	50.63	53.62	56.73	60.00	63.35	66.62	70.00	73.53	77.21
4	81.05	85.05	89.30	93.77	98.50	103.55	108.16	112.92	117.84	122.95
5	128.25	133.77	139.54	145.60	151.96	158.70	164.10	169.60	175.21	180.94
6	185.30	192.75	198.85	205.10	211.50	218.05	223.37	228.64	233.89	239.03
7	244.15	249.23	254.26	259.25	264.19	268.15	273.95	278.77	283.55	287.96
8	293.00									

Kv Values DN 150

Pre-decimal point	Decimal point presetting									
	.0	.1	.2	.3	.4	.5	.6	.7	.8	.9
1	15.22	17.22	19.23	21.23	23.24	25.26	27.24	29.50	31.25	33.26
2	35.26	37.13	39.41	42.30	46.25	53.92	61.00	68.55	76.64	85.40
3	95.02	105.51	114.45	122.36	129.52	135.45	142.21	147.41	153.33	160.00
4	167.12	174.48	181.76	189.05	196.34	203.65	210.78	217.79	224.14	231.46
5	238.91	244.72	251.20	257.60	263.90	272.40	276.24	282.30	288.27	294.17
6	300.40	305.76	311.45	317.08	322.07	326.70	333.58	338.34	344.29	349.56
7	355.60	360.00	365.06	370.13	375.15	382.00	385.04	389.34	394.20	399.54
8	404.30									

Tolerance Curve DN 65 to DN 150

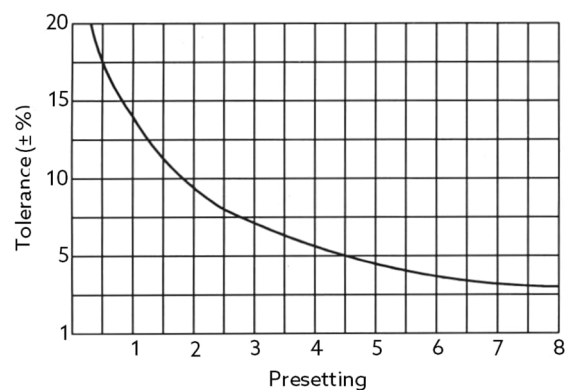

Flow Data DN 200 to DN 300

Kv Values DN 200

Pre-decimal point	Decimal point presetting									
	.0	.1	.2	.3	.4	.5	.6	.7	.8	.9
2	45.9	51.6	54.2	55.8	59.4	62.0	66.4	70.8	75.2	79.8
3	84.0	90.0	96.0	102.0	108.0	114.0	121.0	128.6	136.2	143.6
4	151.0	162.0	173.0	184.0	195.0	206.0	216.8	227.6	238.4	249.2
5	260.3	271.9	283.8	295.6	307.5	320.0	332.0	344.8	357.6	370.3
6	383.0	396.0	409.0	422.0	435.0	447.8	460.0	472.6	484.8	497.2
7	509.5	519.4	529.3	539.2	549.1	559.0	571.0	582.5	594.2	606.0
8	618.0	626.8	634.8	643.2	651.6	660.0	672.8	665.2	693.7	711.6
9	724.5	731.4	738.2	744.9	751.7	758.5	760.6	762.7	764.8	766.9
10	769.0	771.2	773.4	775.6	778.0	780.0	782.0	784.0	786.0	788.0
11	790.0	792.2	794.6	796.8	799.1	801.4	804.0	806.6	809.2	812.0
12	814.5									

Kv Values DN 250

Pre-decimal point	Decimal point presetting									
	.0	.1	.2	.3	.4	.5	.6	.7	.8	.9
2	70	72.5	75.5	79	82	85	89.5	94	99	104.5
3	110	117	123.5	130.5	139	150	155	164	174	184
4	195	208	221	236	252	270	287	304	321	338
5	356	373	390	407	423	440	457	473	490	506
6	522	539	555	571	587	607	619	635	651	666
7	682	698	714	729	745	760	778	795	811	826
8	840	850	860	870	880	890	899	907	916	925
9	933	942	952	961	970	980	989	998	1008	1018
10	1028	1038	1048	1059	1071	1080	1088	1096	1104	1112
11	1120	1128	1136	1144	1152	11160	1168	1176	1184	1192
12	1200									

Kv Values DN 300

Pre-decimal point	Decimal point presetting									
	.0	.1	.2	.3	.4	.5	.6	.7	.8	.9
2	200	210	220	230	240	250	261	273	285	297
3	310	323	336	350	365	380	401	421	441	461
4	480	499	517	535	553	570	588	606	624	642
5	660	678	696	714	732	750	771	791	810	828
6	845	861	877	892	906	920	933	947	961	975
7	990	1005	1020	1036	1053	1070	1084	1098	1112	1126
8	1140	1154	1168	1182	1196	1210	1228	1245	1261	1276
9	1290	1303	1316	1328	1339	1350	1365	1379	1393	1407
10	1420	1433	1446	1457	1468	1480	1490	1500	1510	1520
11	1530	1539	1547	1555	1563	1570	1577	1583	1589	1595
12	1600									

Tolerance Curve DN 200 to DN 300

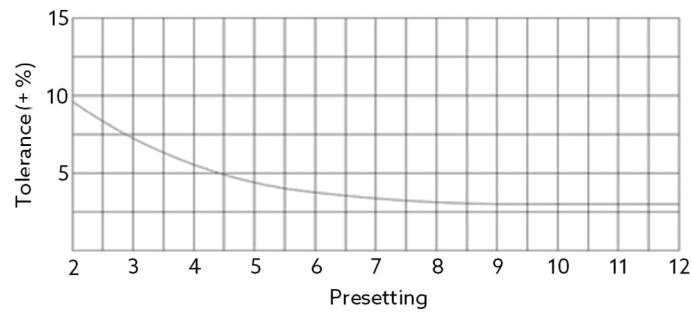

Flow Data DN 350 and DN 400

Kv Values DN 350

Pre-decimal point	Decimal point presetting									
	.0	.1	.2	.3	.4	.5	.6	.7	.8	.9
3	290	299	308	318	328	340	350	361	374	387
4	400	414	429	445	462	480	499	518	537	556
5	575	588	615	635	655	675	696	716	737	758
6	800	818	836	854	872	890	912	934	956	978
7	1000	1018	1036	1054	1072	1090	1108	1126	1144	1162
8	1180	1192	1204	1216	1228	1240	1252	1264	1276	1288
9	1300	1312	1324	1336	1348	1360	1372	1384	1396	1408
10	1420	1434	1448	1462	1476	1490	1504	1518	1532	1546
11	1560	1571	1582	1593	1604	1615	1626	1637	1648	1659
12	1670	1682	1694	1706	1718	1730	1742	1754	1766	1778
13	1790	1802	1814	1826	1838	1850	1862	1874	1886	1898
14	1910	1920	1930	1940	1950	1960	1970	1980	1990	2000
15	2010	2019	2028	2037	2046	2055	2064	2073	2082	2091
16	2100	2108	2116	2124	2132	2140	2148	2156	2164	2172
17	2180	2187	2194	2201	2208	2215	2222	2229	2236	2243
18	2250									

Kv Values DN 400

Pre-decimal point	Decimal point presetting									
	.0	.1	.2	.3	.4	.5	.6	.7	.8	.9
3	338	352	365	379	392	406	420	433	447	460
4	474	497	520	544	567	590	611	632	653	674
5	695	720	745	770	795	820	845	870	895	920
6	945	972	998	1025	1051	1078	1104	1131	1157	1184
7	1210	1235	1261	1286	1312	1337	1362	1387	1413	1438
8	1463	1489	1515	1540	1566	1592	1617	1645	1672	1698
9	1725	1746	1767	1788	1809	1830	1852	1873	1894	1915
10	1936	1954	1972	1990	2008	2026	2044	2062	2080	2098
11	2116	2137	2158	2180	2201	2222	2243	2264	2286	2307
12	2328	2348	2368	2388	2408	2428	2449	2469	2489	2509
13	2529	2547	2566	2584	2602	2621	2639	2657	2675	2694
14	2712	2729	2746	2762	2779	2796	2813	2830	2846	2863
15	2880	2891	2901	2912	2922	2933	2944	2954	2965	2975
16	2986	2999	3012	3025	3038	3051	3064	3076	3089	3102
17	3115	3126	3137	3148	3159	3170	3182	3193	3204	3215
18	3226	3235	3245	3254	3264	3273	3282	3292	3301	3311
19	3320	3329	3338	3347	3356	3365	3374	3383	3392	3401
20	3410	3418	3426	3434	3442	3450	3458	3466	3474	3482
21	3490	3500	3510	3520	3530	3540	3550	3560	3570	3580
22	3590	3599	3608	3517	3626	3635	3644	3653	3662	3671
23	3680	3687	3694	3701	3708	3715	3722	3729	3736	3743
24	3750									

Tolerance Curve DN 350 and DN 400

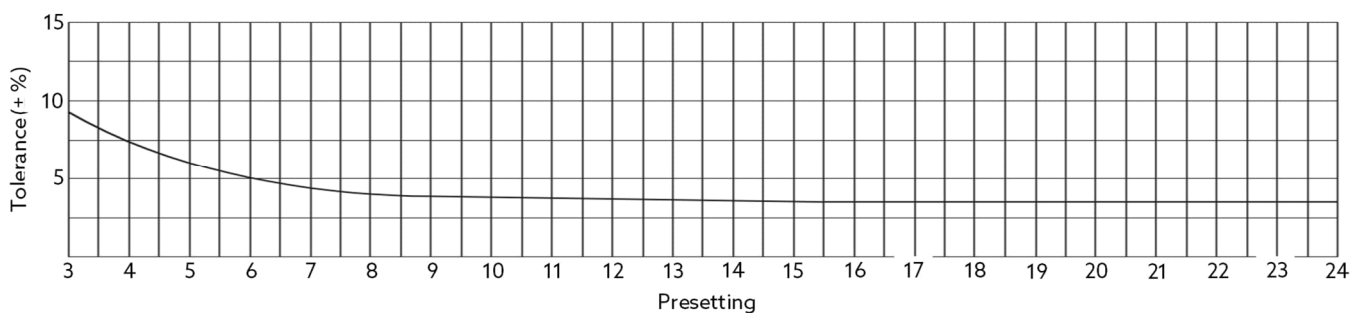

Flow Charts

DN 20

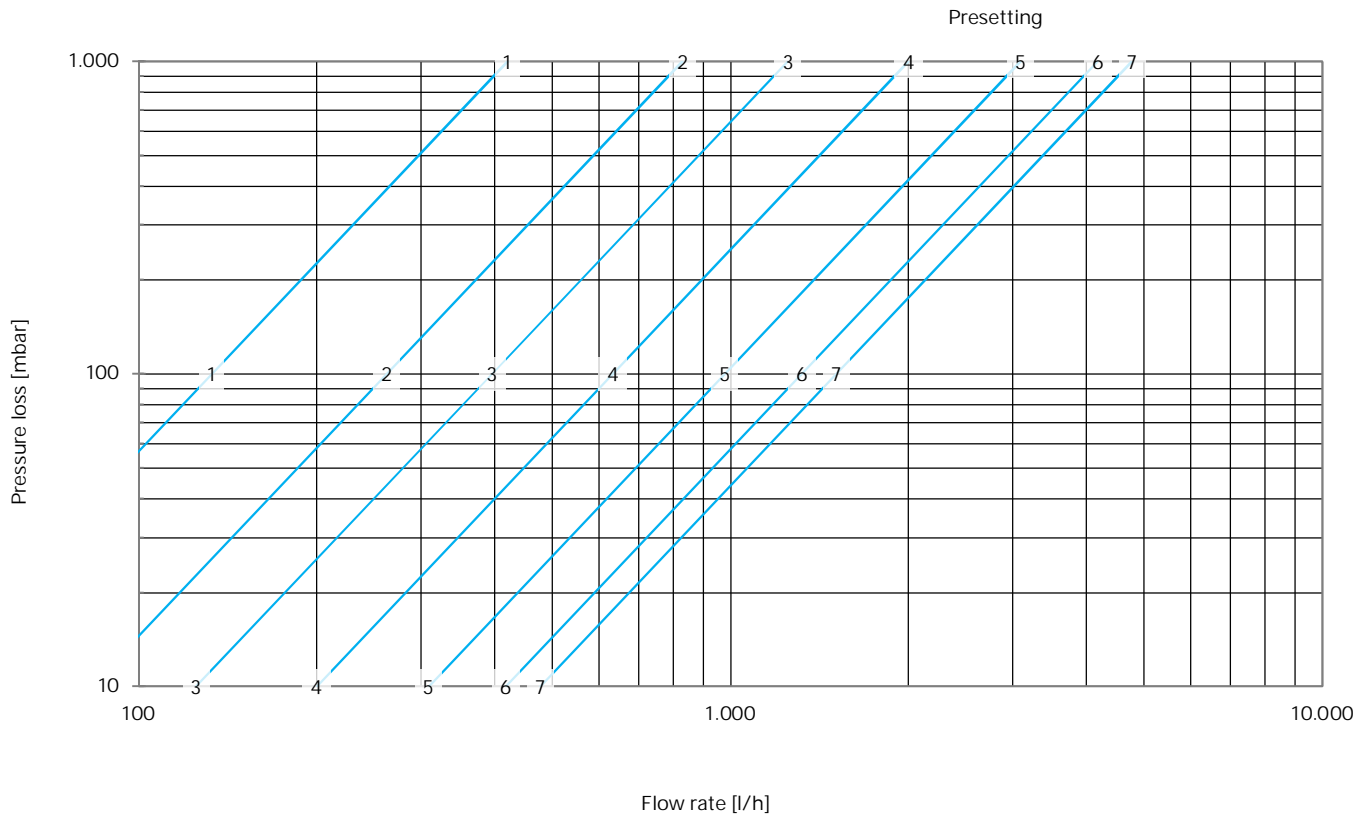

DN 25

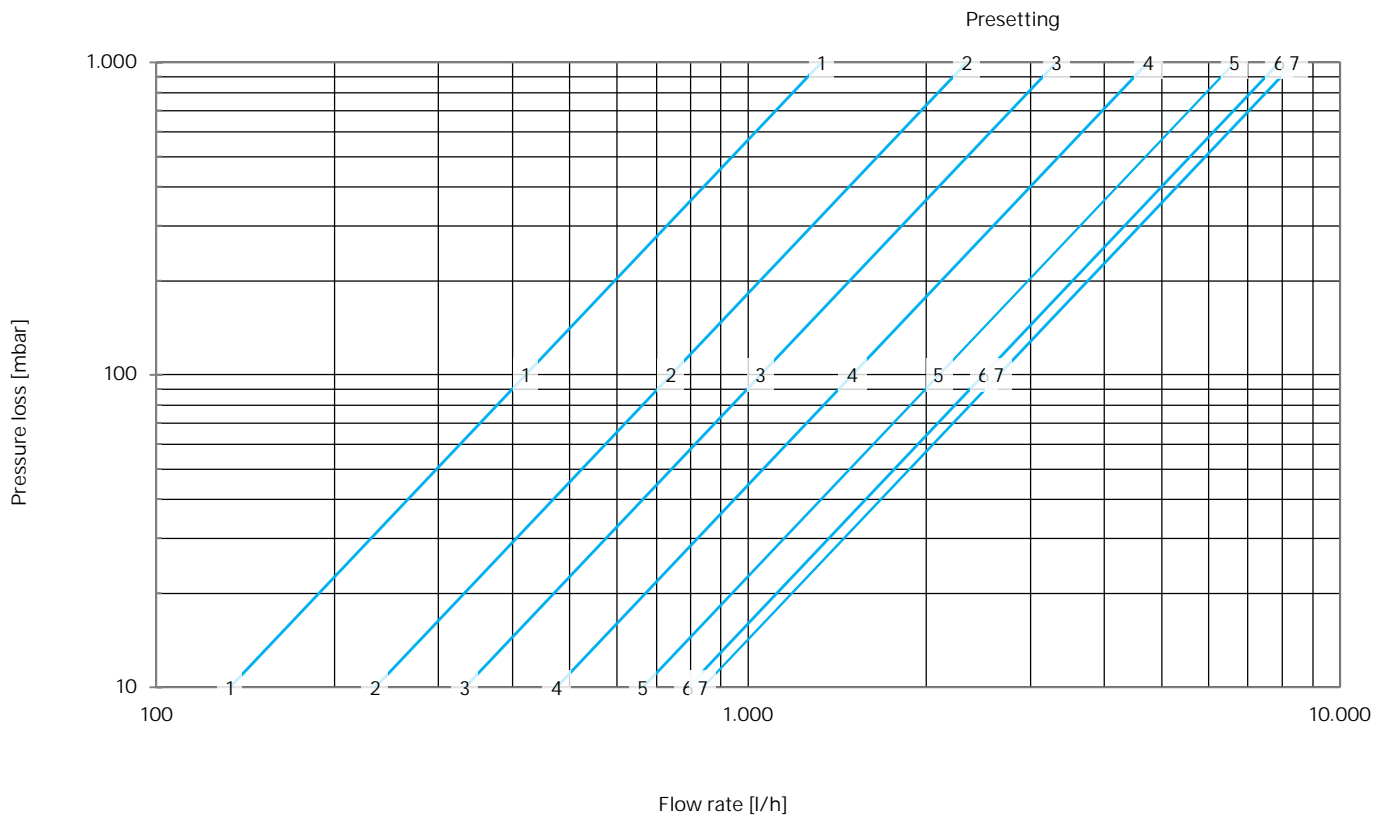

DN 32

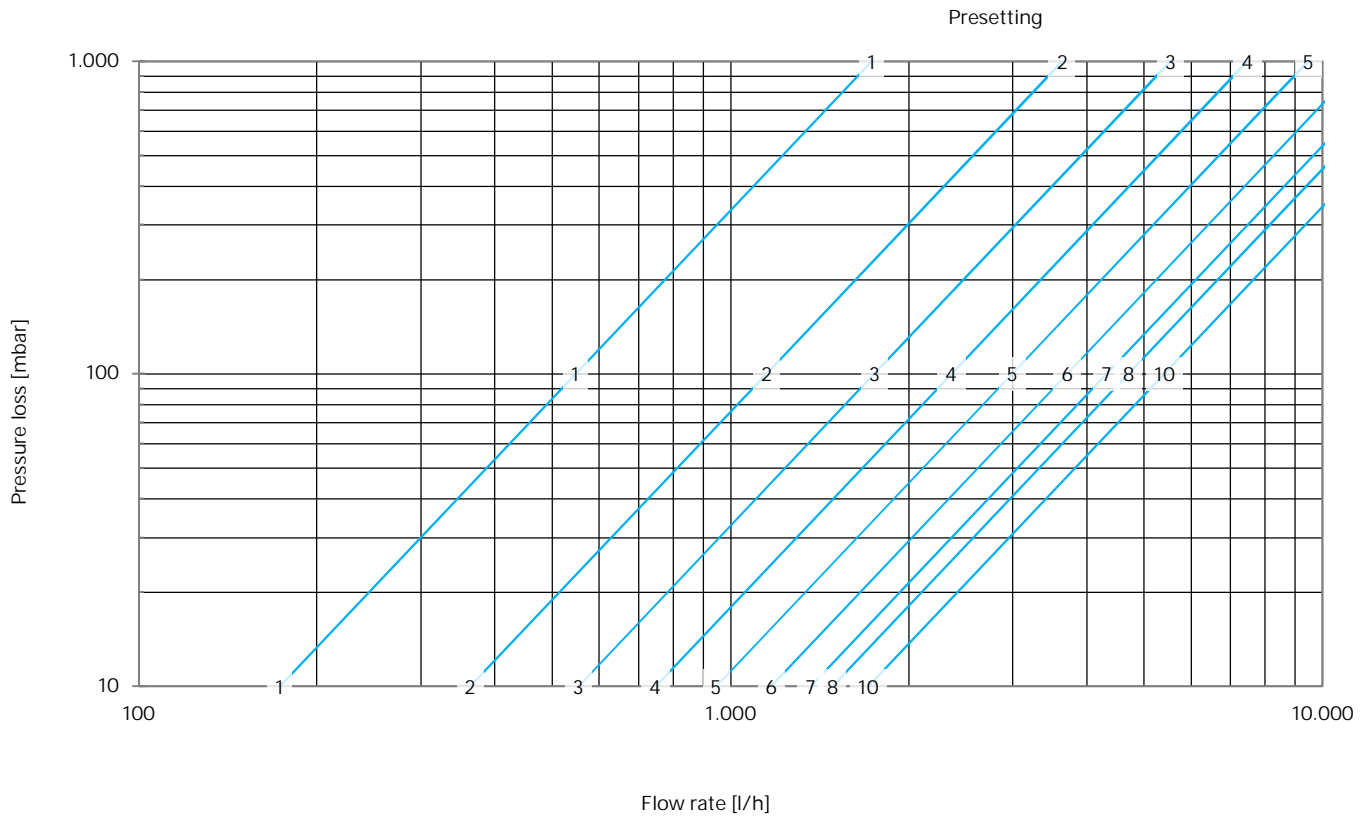

DN 40

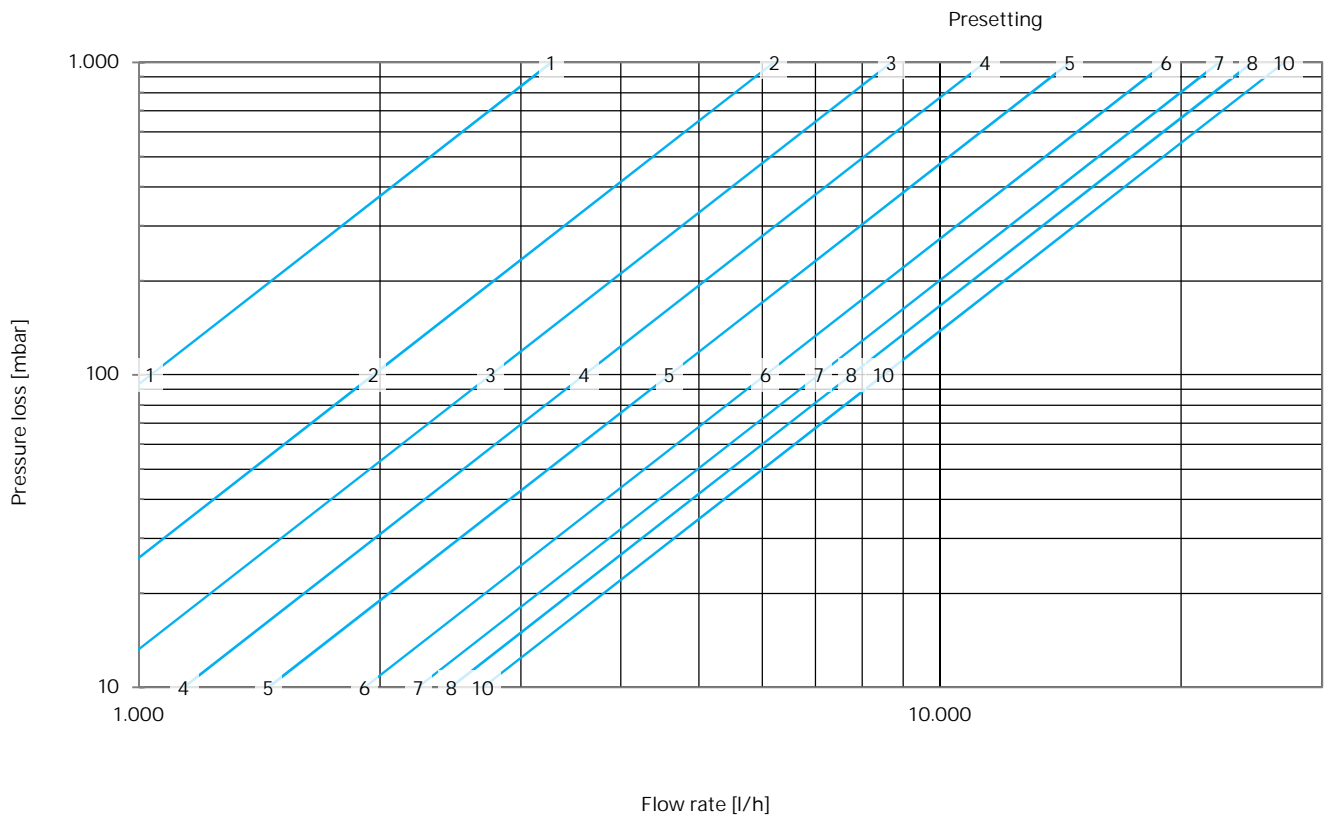

DN 50

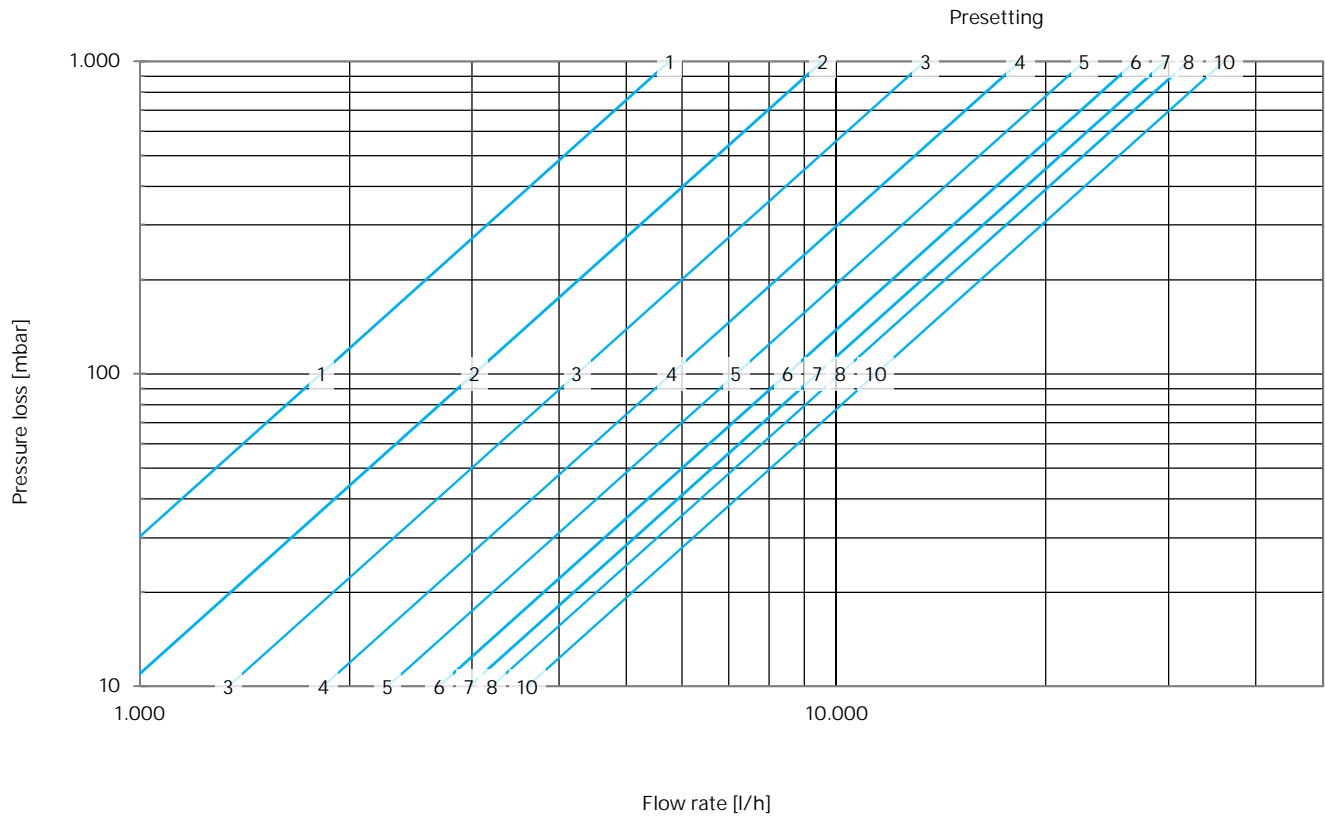

DN 65

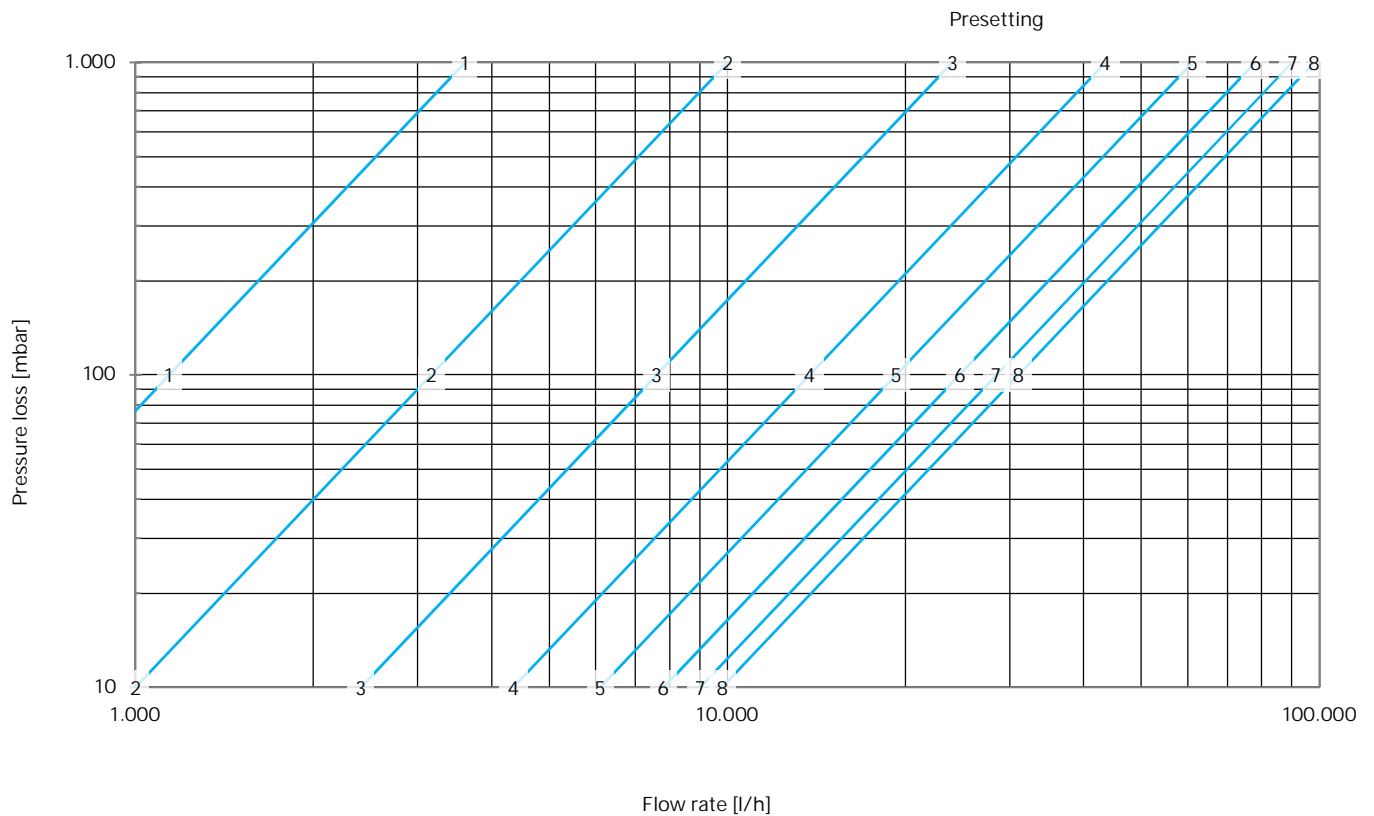

DN 80

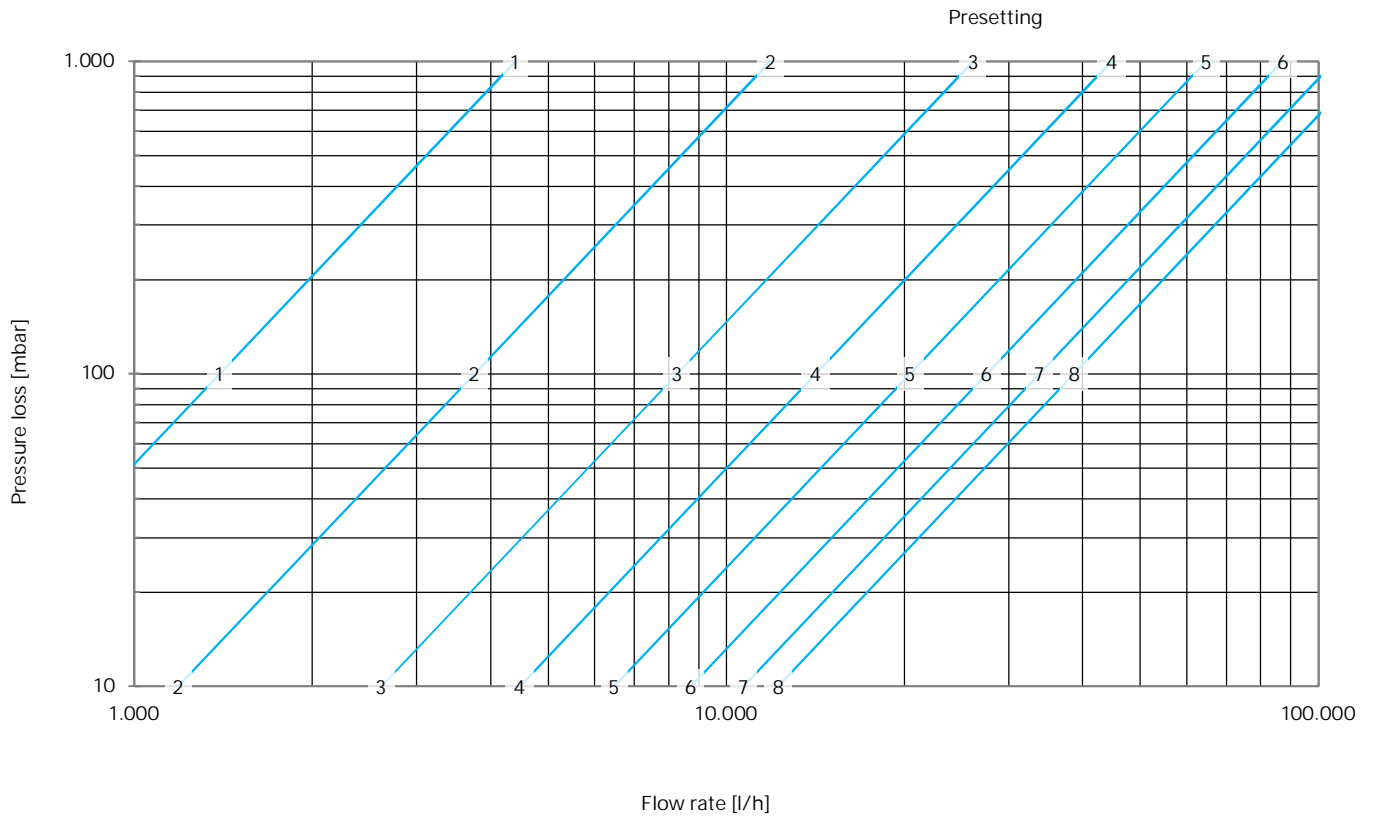

DN 100

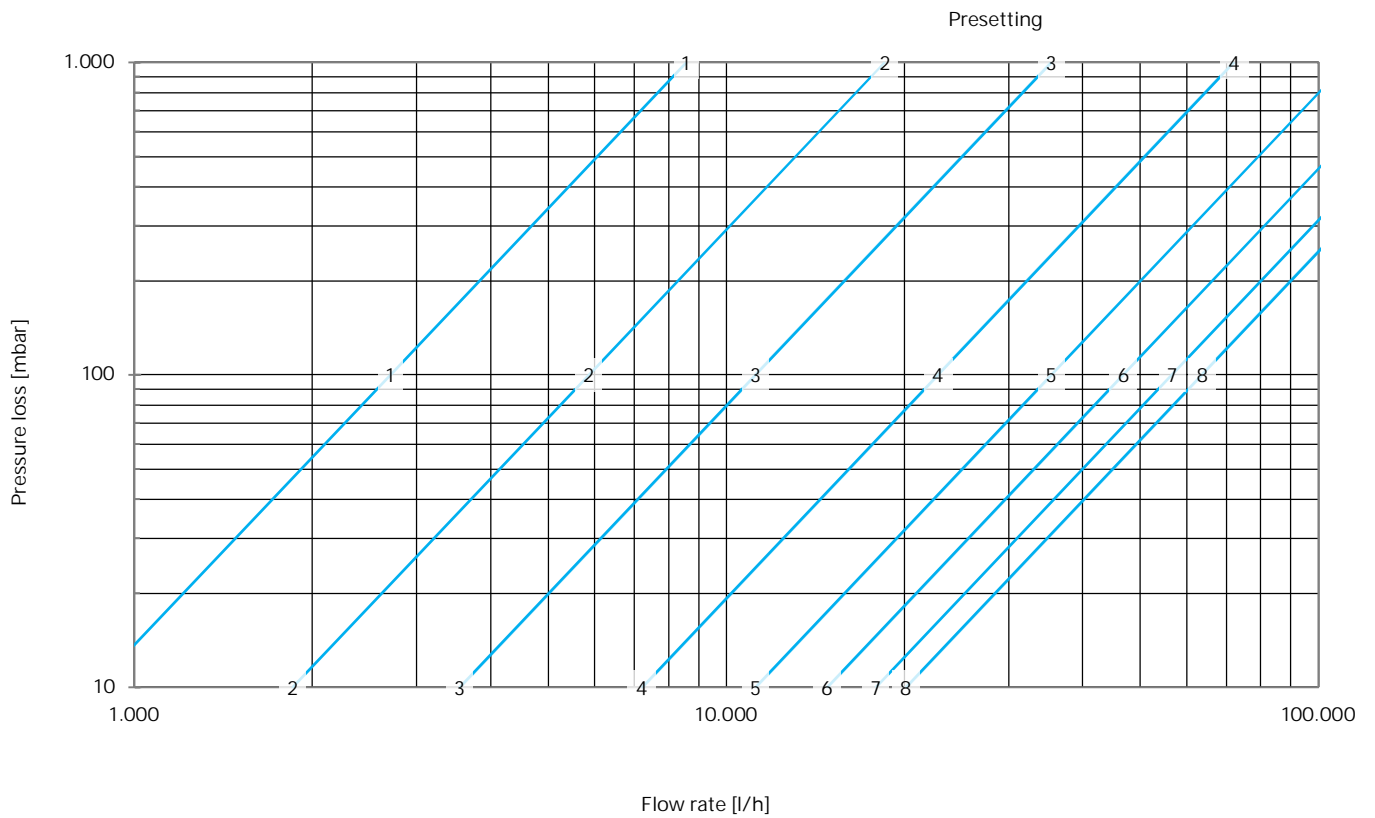

DN 125

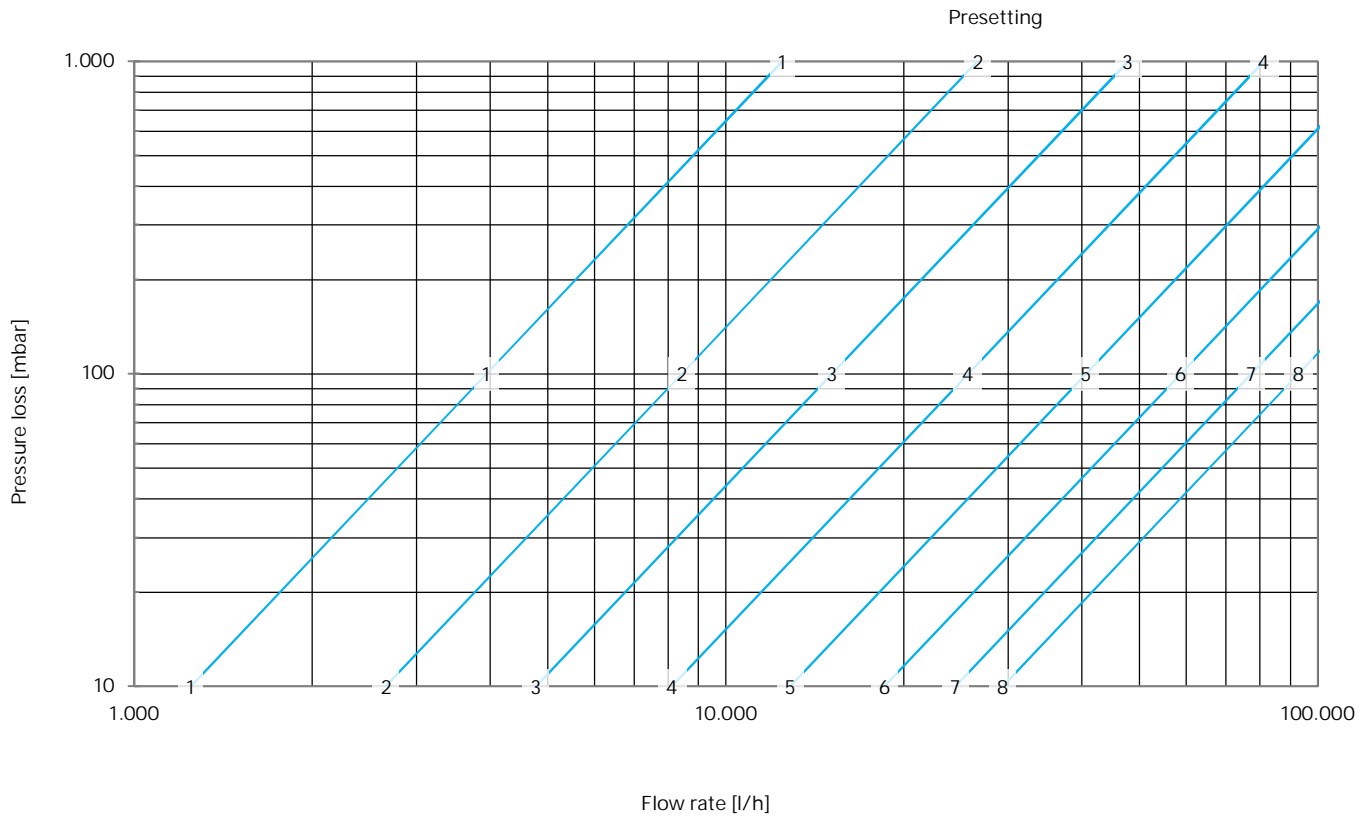

DN 150

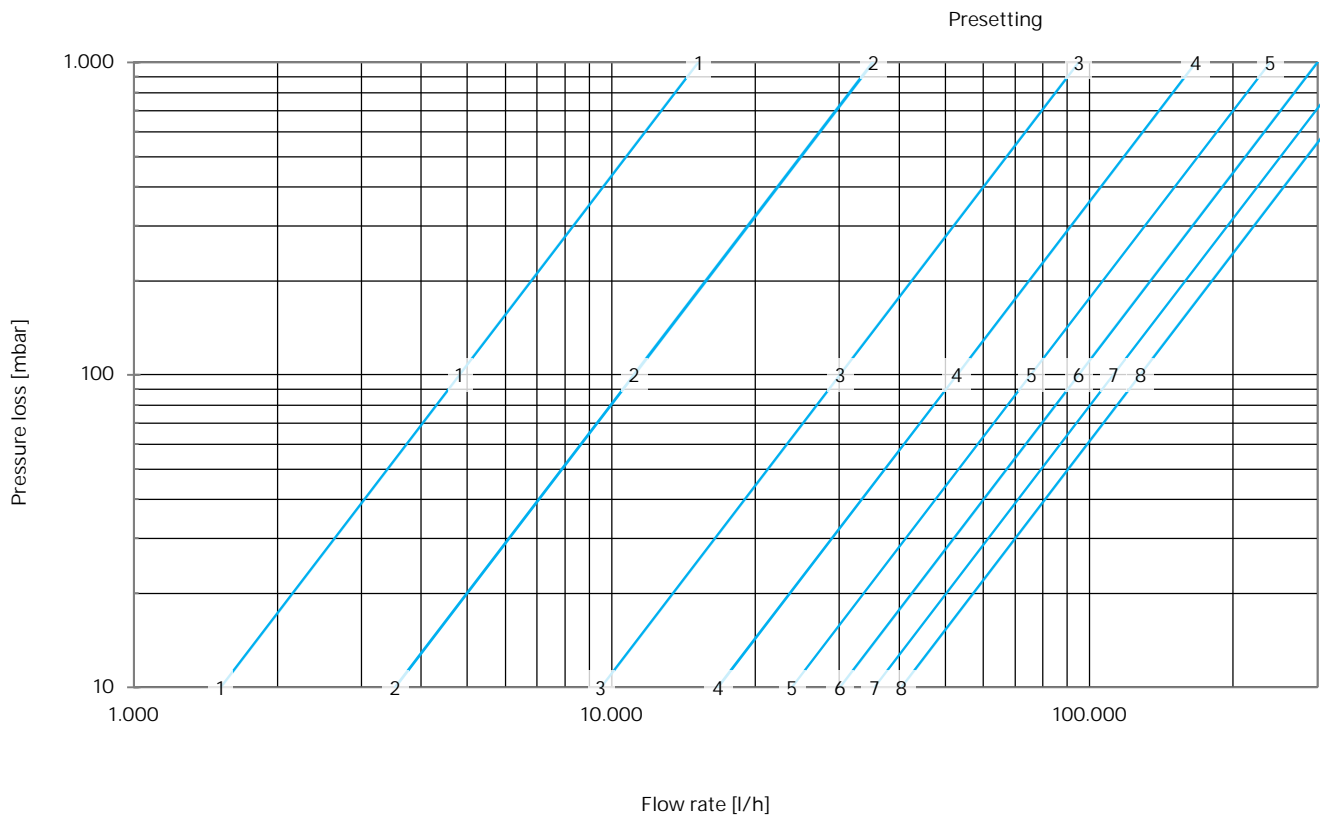

DN 200

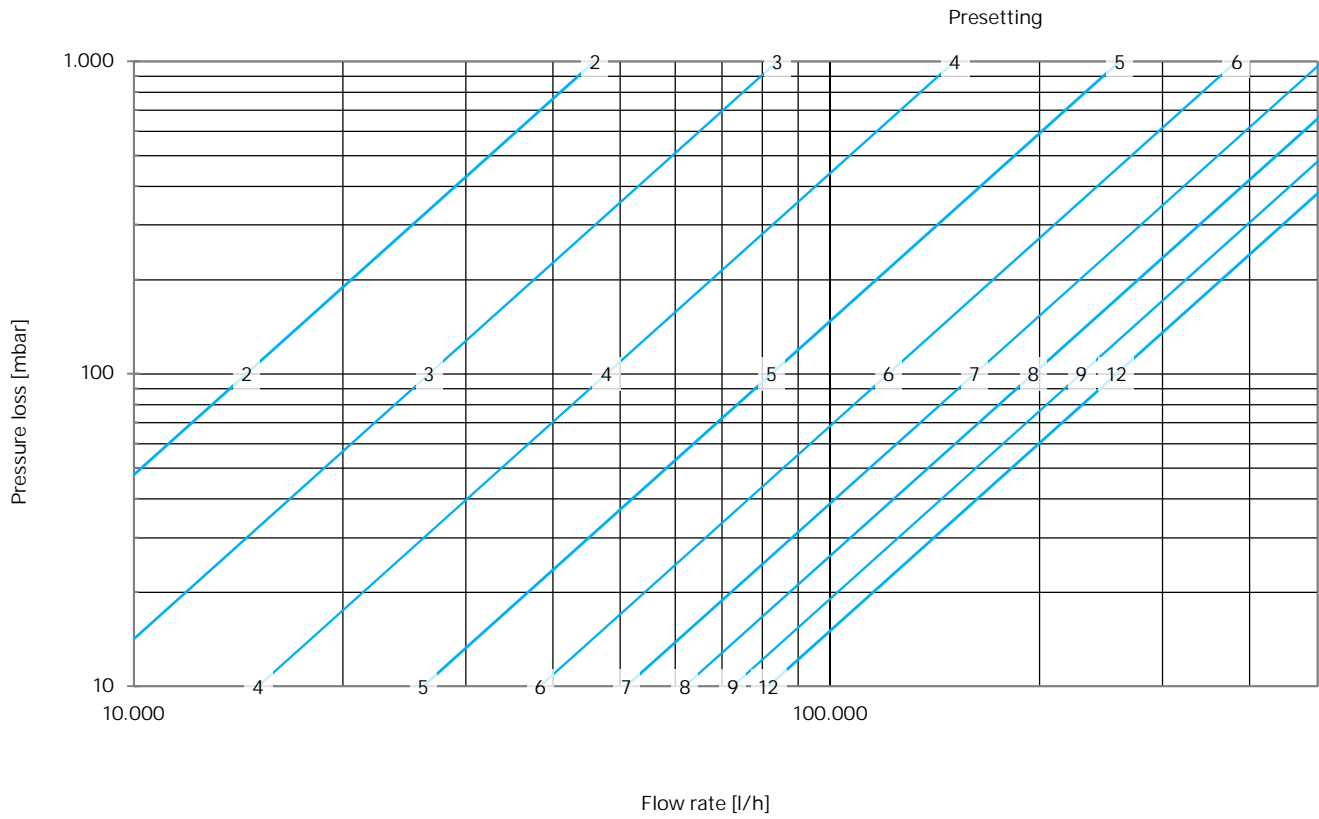

DN 250

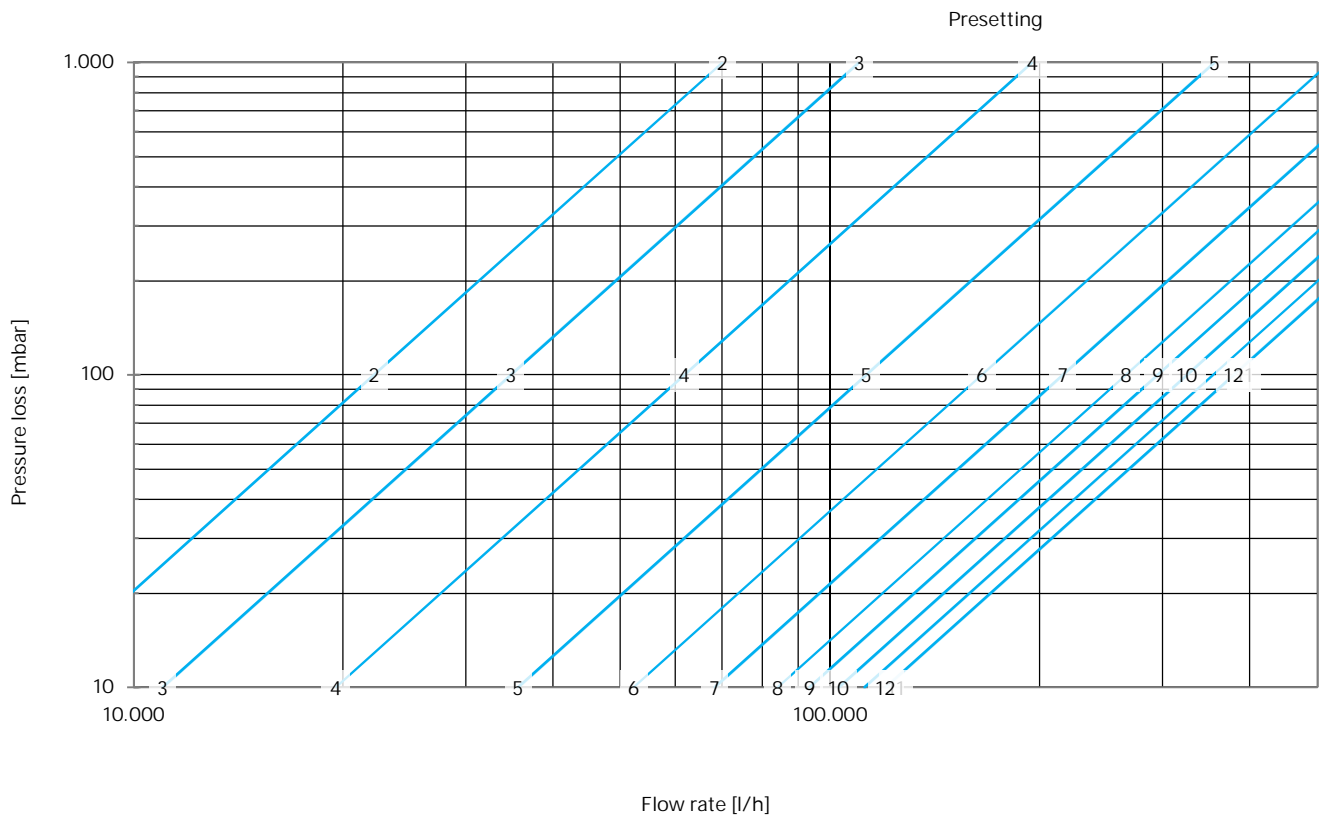

DN 300

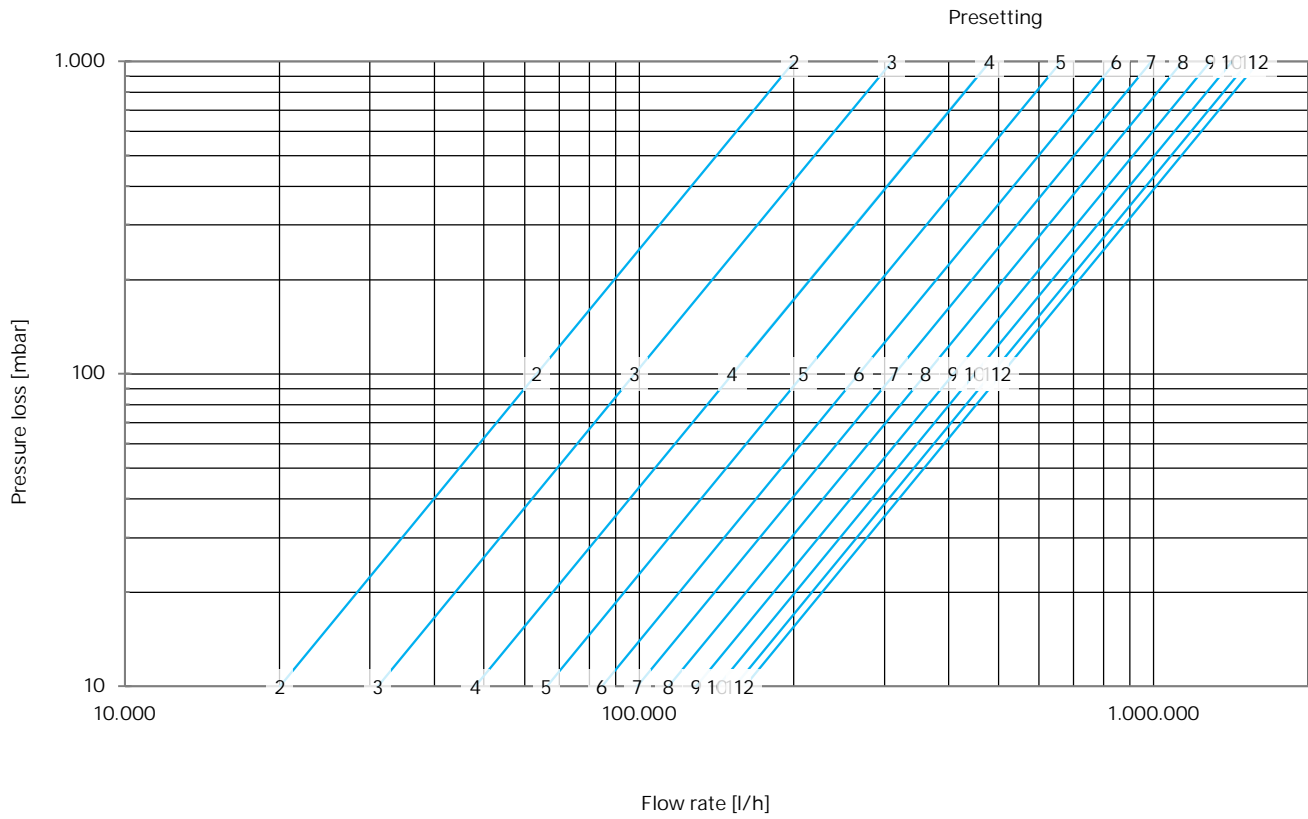

DN 350

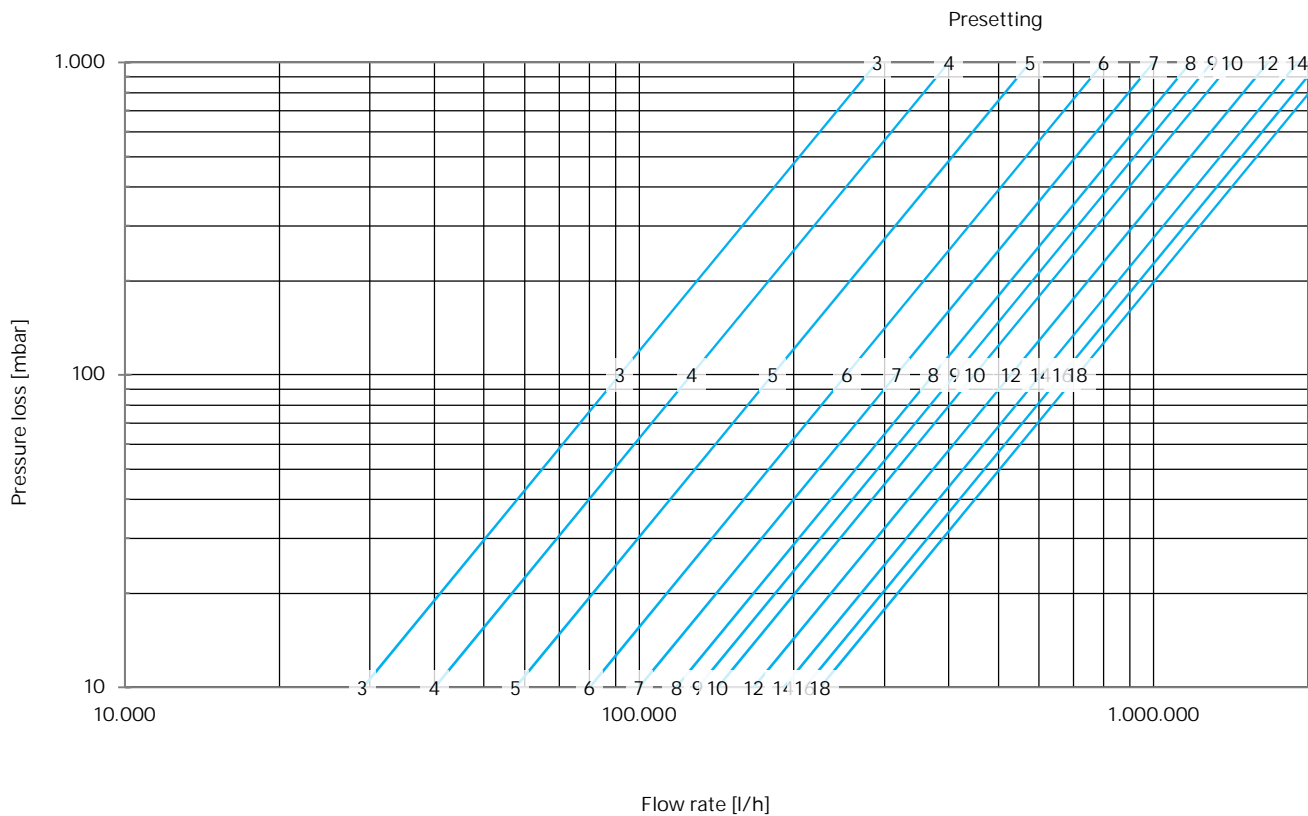

DN 400

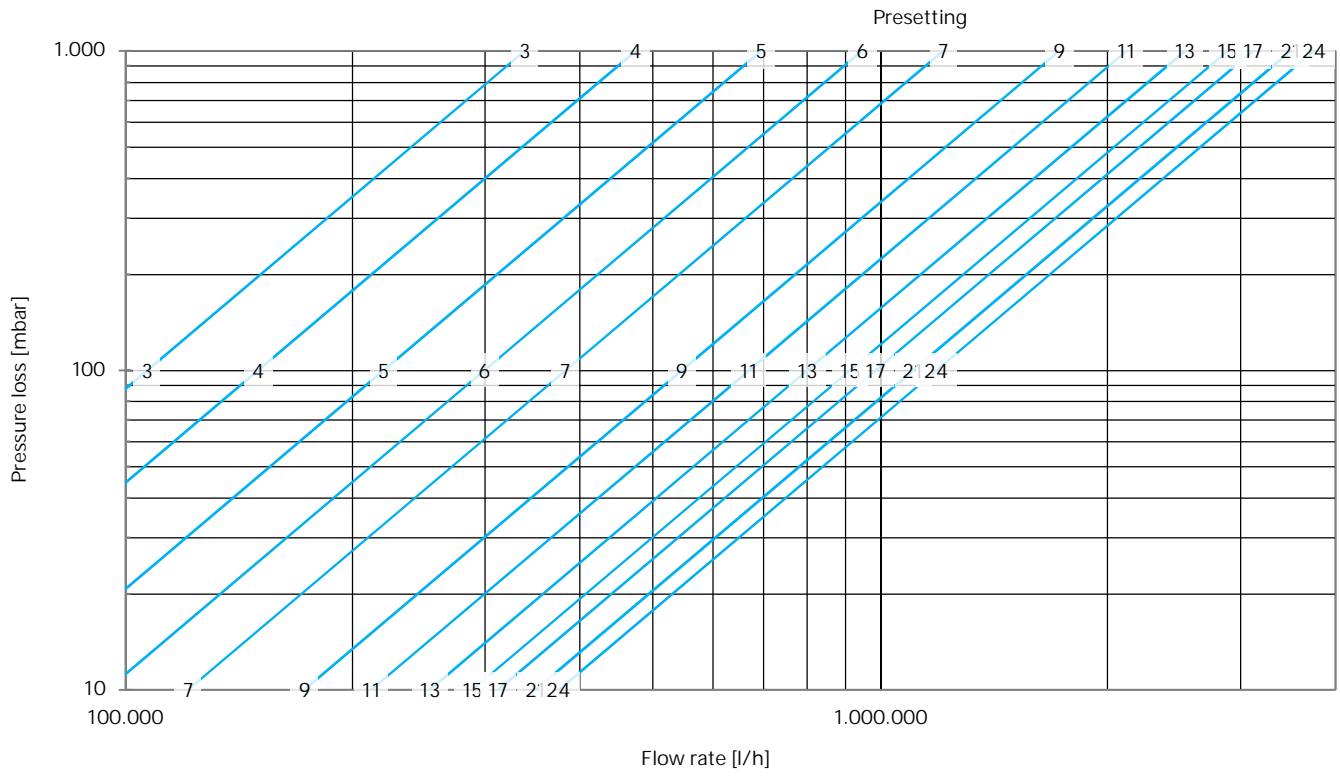

Kv Value Calculation

The flow coefficient Kv is the volume of water in m³ that flows through an opening within one hour with a pressure loss of 1 bar. For control and regulating valves, this opening is typically the gap between the valve seat and the valve plug. The required Kv value can be easily calculated with the Kv formula:

$$Kv = Q \times \sqrt{\frac{1 \text{ bar}}{\Delta P} \times \frac{\rho}{1000 \frac{\text{kg}}{\text{m}^3}}}$$

- Q is the volume flow in m³/h
- ΔP is the pressure loss in bar
- ρ is the density in kg/m³ — water with a temperature of 4 °C has a density of 1,000 kg/m³. At 50 °C water has a density of 988 kg/m³, at 70 °C of 978 kg/m³ and at 100 °C of 958 kg/m³

For use with Excel or other spreadsheets, the formula is:

$$=Q*\text{ROOT}((1/DP)*(p/1000))$$

The objects in **semibold cyan** are to be replaced by values or cell references. Brackets have been added for easier mapping.

C4				=C1*ROOT(1/C2*C3/1000)
	A	B	C	D
1	Volume flow	Q	0.5 m ³ /h	
2	Pressure loss	Dp	0.1 bar	
3	Density	p	988 kg/m ³	
4		Kv	1.57	

For an accurate Kv value calculation, you need the water temperature so that you can look up the density and enter the value into the formula. If a less precise calculation is sufficient, the formula can be simplified by shortening the second fraction by setting the density to 1,000 kg/m³ - which only applies to a water temperature of 4 °C, as mentioned above. The error in a Kv value calculated in this way is approx. 1 % for water with a temperature of e.g. 70 °C (density 978 kg/m³).

To be calculated	Formula	Spreadsheet formula
Kv value (simplified)	$Kv = Q \times \sqrt{\frac{1 \text{ bar}}{\Delta P}}$	=Q*ROOT(1/DP)

Correction Factors

Additives change the viscosity of water and thus its flow properties. Manufacturers of additives often provide calculation aids that take into account the changed properties of the medium when using their products.

The flow data in this data sheet are based on the properties of water without additives. A quick, but only approximate calculation of the changed flow values when using glycol mixtures is made with the correction factor f, which can be used to recalculate the Kv value or the required pressure loss:

To be calculated	Formula	Spreadsheet formula
Kv value (corrected)	$Kv_{(corr)} = Kv \times \frac{1}{\sqrt{f}}$	Kv*(1/(ROOT(f)))
Pressure loss (corrected)	$\Delta P_{(corr)} = \Delta P \times f$	DP*f

The correction factor can be read in the following two charts at the intersection of the values for media temperature and glycol content.

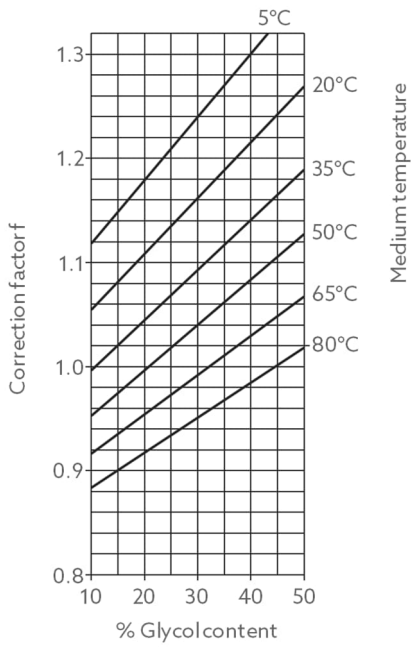

Correction factor f for ethylene glycol

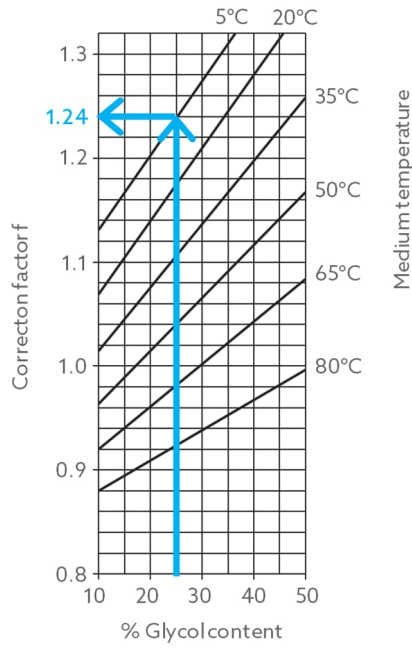

Correction factor f for propylene glycol

Example:

A glycol content of 25 % and a medium temperature of 5 °C result in a factor of 1.24 with the following impacts:

- If the original Kv value was 10, it is now reduced to just short of 9
- If the original flow rate was 10 m³/h, it is now reduced to just short of 9 m³/h (at the same differential pressure)
- If the original differential pressure was 10 kPa, it must now be increased to 12.4 kPa to ensure the same flow rate

Subject to change without notice • All rights reserved • © 2022 Oventrop GmbH & Co. KG
EN-03102-106235-DB-V2131 – July 2022