

Kol. Opis

1 MAGNA3 D 32-120 F



Paznja! Slika proizvoda se može razlikovati od stvarnog proizvoda

Proizvodni broj: [97924454](#)

The Grundfos MAGNA3 D circulator pump is the ideal choice for almost any building project – old or new. With its unrivalled energy efficiency, all-encompassing range and built-in communication capabilities, MAGNA3 D is ideal for engineers and specifiers looking to create high-performance heating and cooling systems.

The pump is maintenance-free due to the canned-rotor type design. This also means that pump and motor form an integral unit without shaft seal and with only two gaskets for sealing. The bearings are lubricated by the pumped liquid.

MAGNA3 D offers three multipump modes: Alternating, backup and cascade operation.

In alternating and backup operation, only one pump operates at a time, both ensuring constant comfort.

In alternating operation, the change from one pump to the other depends on time or energy.

If a pump fails, the other pump will take over automatically.

In backup operation, the backup pump is operated at intervals to prevent seizing up.

If the duty pump stops due to a fault, the backup pump will start automatically.

In cascade operation, the pumps automatically switch on and off, adapting to the current consumption in the system.

The two pumps communicate wirelessly.

MAGNA3 D features an intuitive display and allows you to connect wirelessly with the Grundfos GO Remote app, giving you access to advanced reporting and monitoring.

MAGNA3 model E has Bluetooth, which allows you to connect directly to Grundfos Go app on your smart phone without any need for a dongle.

The pump includes fieldbus communication via CIM modules as well as analog and digital inputs and configurable relays.

Control features include AUTOADAPT and FLOWADAPT. FLOWADAPT which reduces the need for throttling valves, thus cutting costs on system components.

MAGNA3 D is the superior choice for a wide range of heating and cooling applications, including:

- Mixing loops
- Heating surfaces
- Air conditioning surfaces
- Ground-source heat pump systems
- Smaller chiller applications.

MAGNA3 D is a single-phase pump and characterised by having the controller and display integrated in the control box. The pump also has a built-in differential-pressure and temperature sensor.

The pump housing is available in both cast-iron and stainless-steel versions. The composite rotor can is carbon-fibre reinforced, the bearing plate and rotor cladding are made of stainless steel and the stator housing is made of aluminium. The power electronics are air-cooled.

MAGNA3 incorporates a 4-pole synchronous, permanent-magnet motor (PM motor). This motor type is characterised by higher efficiency than a conventional asynchronous squirrel-cage motor. The pump speed is controlled by an integrated frequency converter.

97924454 MAGNA3 D 32-120 F

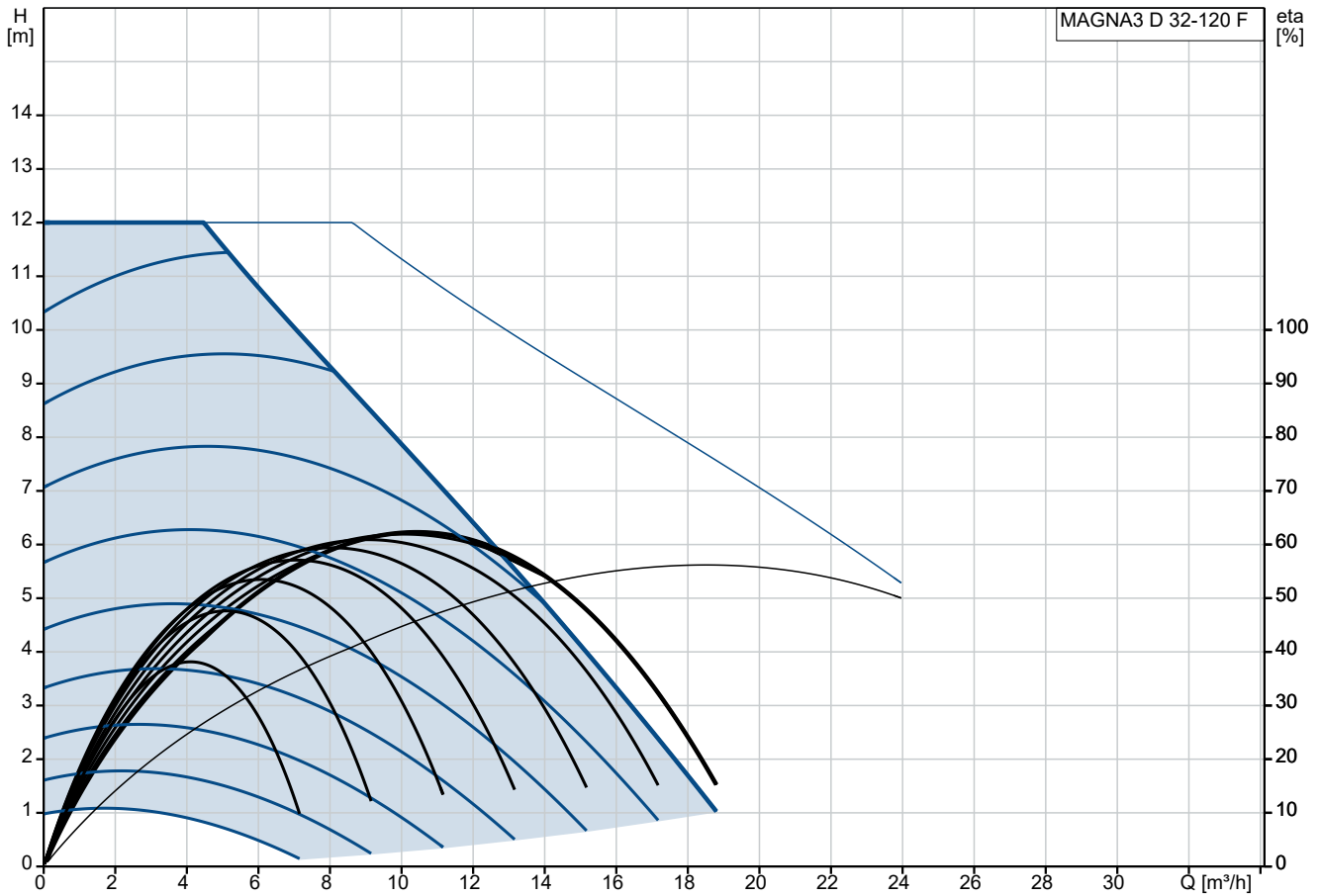

Dizana tečnost = voda
 Temperatura tečnosti tokom rada = 60 °C
 Gustina = 983.2 kg/m³

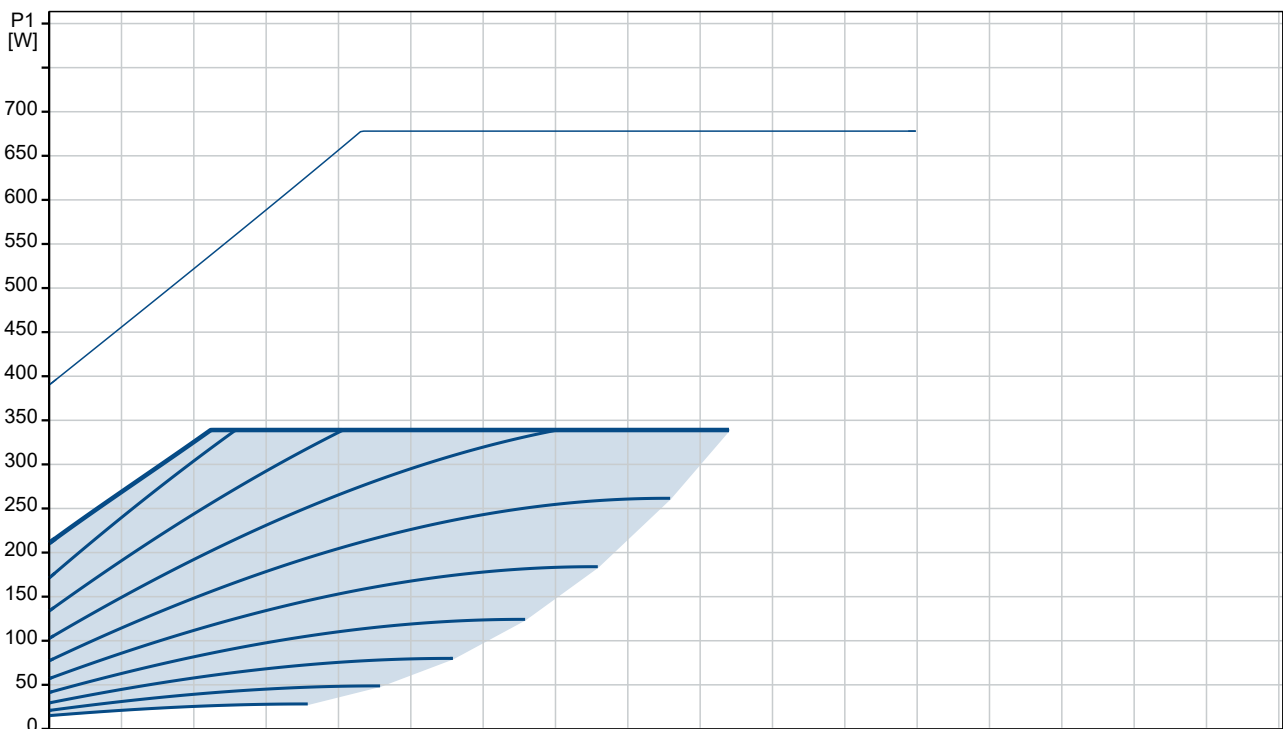

97924454 MAGNA3 D 32-120 F

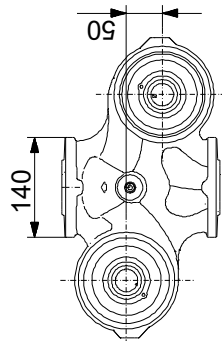
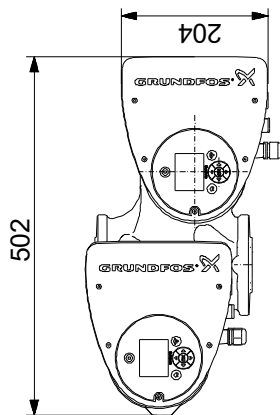
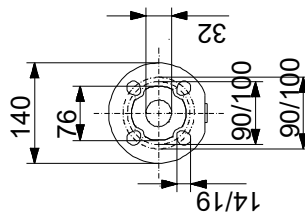
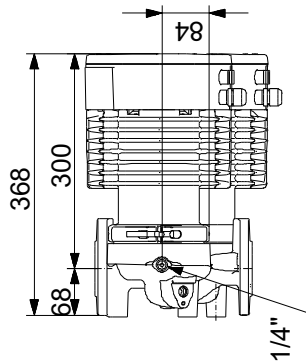
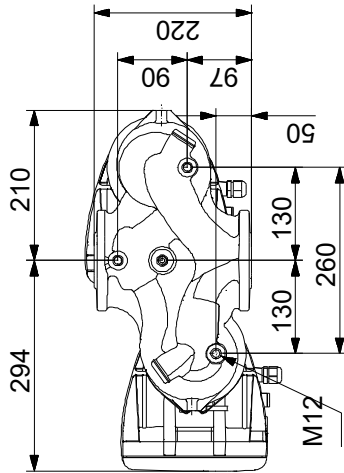

Napomena! Sve jedinice su u [mm]ukoliko drugačije nije navedeno.
Upozorenje: Ovaj pojednostavljeni dimenzioni crtež ne pokazuje sve detalje.

97924454 MAGNA3 D 32-120 F

Example of mains-connected motor with mains switch, backup fuse and additional protection

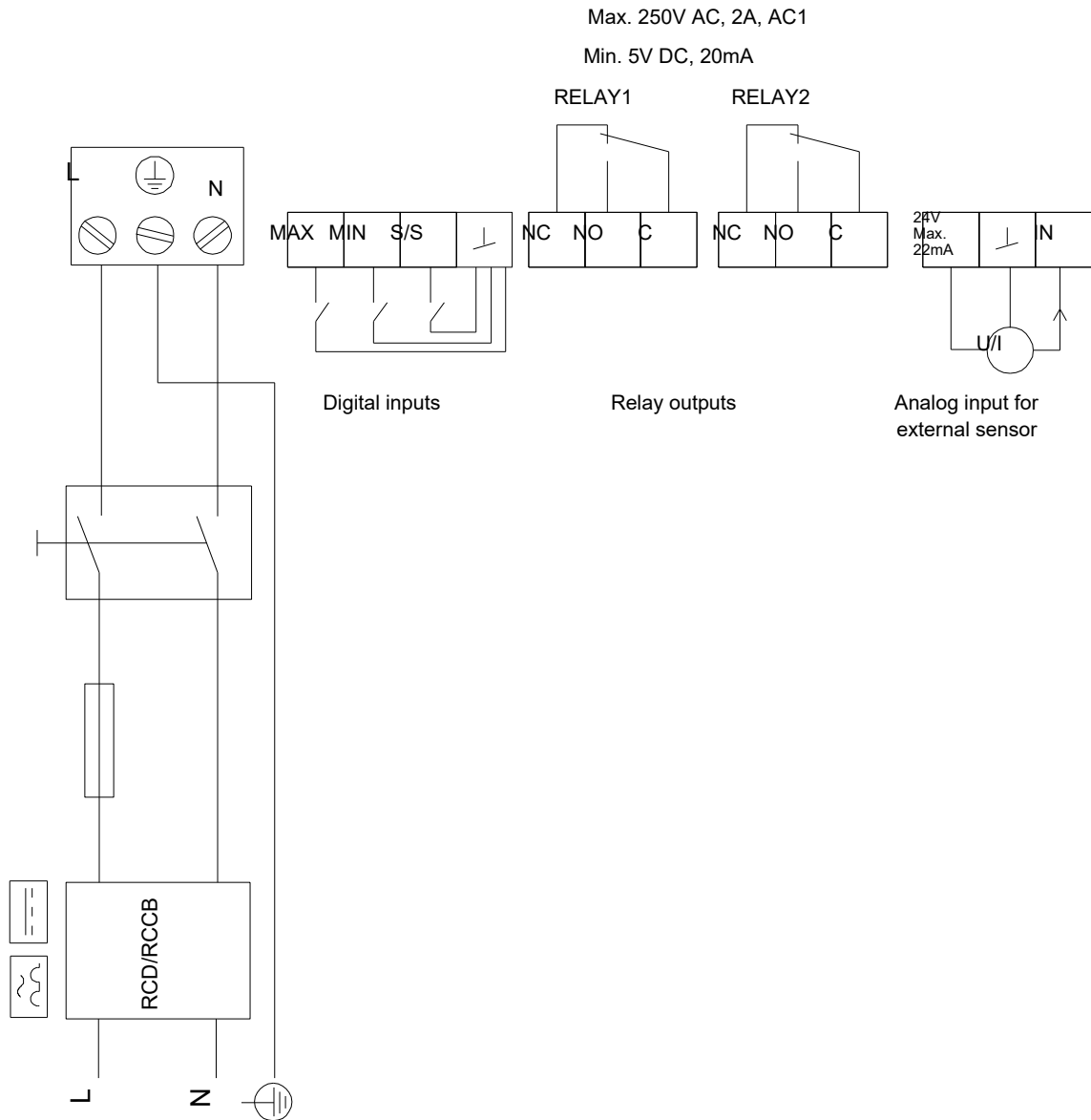

Pažnja! Sve jedinice su u [mm] ukoliko nije rečeno drugačije.